



OPERATION, MAINTENANCE, AND INSTALLATION GUIDE

Zenith ZTS T-series

For ZTS(D) T-series automatic transfer switches, 30-1200 A, 200-480 Vac



Receiving, handling and storage

**Warning**

Indicates a hazardous situation that, if not avoided, could result in death or serious injury.

HAZARD OF EQUIPMENT OVERTURNING

When moving with a fork lift, do not remove the shipping packaging until the device is in its final location.

Failure to follow this instruction may result in personal injury or equipment damage.

Receiving and handling

Upon receipt, carefully inspect the transfer switch for damage that may have occurred during transit. If damage is evident, or there is visible indication of rough handling, immediately file a damage claim with the transportation company, and notify your local ABB sales office.

Do not remove the shipping packaging until ready to install the switch.

Storage

If the unit will not be placed into service immediately, store the transfer switch in its original package in a clean, dry location. To prevent condensation, maintain a uniform temperature. Store the unit in a heated building, allowing adequate air circulation and protection from dirt and moisture. Storing the unit outdoors could cause harmful condensation inside the transfer switch enclosure.

Read these safety instructions carefully before using this product!

**Danger**

Indicates a hazardous situation that, if not avoided, will result in death or serious injury.

HAZARD OF ELECTRIC SHOCK, EXPLOSION, OR ARC FLASH

- Apply appropriate personal protective equipment and follow safe electrical work practices.
- This equipment must only be installed and serviced by qualified electrical personnel.
- Before performing visual inspections, tests, or maintenance on the equipment, disconnect all sources of electric power. Assume that all circuits are live unless they are completely de-energized, tested, grounded, and tagged. Pay particular attention to the design of the power system. Consider all sources of power, including the possibility of backfeeding.
- Disconnect all sources of electric power before removing or making source side or load side connections to the transfer switch.
- Always use a properly rated voltage sensing device at all line and load connections to confirm transfer switch is disconnected from all live electrical sources.
- Turn off power supplying transfer switch before doing any other work on or inside switch.

Failure to follow these instructions could result in death or serious injury.

Operation, maintenance, and installation instruction

Automatic transfer
switches, Zenith
ZTS T-series ATS

OPERATION AND MAINTENANCE
INSTRUCTIONS, ZENITH
ZTS T-SERIES ATS,
CHAPTERS 1–8

INSTALLATION INSTRUCTIONS,
ZENITH ZTS T-SERIES ATS,
CHAPTERS 9–11

1

2



Operation and maintenance instruction

Automatic transfer switches, Zenith ZTS T-series ATS

1. Introduction	11
1.1 Hazard Categories	11
1.2 Definitions	12
1.3 Warranty	13
1.4 Product Specification	14
2. Product overview	15
2.1 General overview	16
2.1.1 Operation types	17
2.2 HMI	18
2.3 Zenith ZTS T-series features	19
2.4 Typical applications	22
2.5 Sequence of operations	24
2.5.1 Switching sequence / Automatic	24
2.6 Special features description	30
2.6.1 Automatic configuration	30
2.6.2 In-phase monitor	30
2.6.3 Powering supply scenarios	30
3. General operation	31
3.1 Position indication	31
3.2 Operating and locking	32
3.3 Manual handle operation	33
3.4 Return to automatic mode, operating by HMI	35
3.5 LED functionality in HMI	36
3.6 Using Level 4 (touch) control interdice HMI	38
3.6.1 Keypad	38
3.6.2 Navigating in menu	38

4. Navigating HMI menu 39

4.1 Start Menu	39
4.2 Using main menu and setting parameters	41
4.3 Menus and parameters	42
4.4 Analog meters and Measures	55

5. Electronic accessories 57

5.1 Using Ekip Connect -software	58
5.2 Using Ekip Programming -mode	59
5.2.1 LED indications	59
5.3 Auxiliary power supply module	60
5.3.1 Electrical characteristics	60
5.3.2 LED indications	60
5.4 Using Ekip Signalling 2K_-module	61
5.4.1 Electrical characteristics of Ekip Signalling 2K_-module	61
5.4.2 Access from the display / Ekip Signalling 2K_-module	61
5.4.3 LED indications and inputs/outputs of Ekip Signalling 2K_-module	65
5.5 Using Ekip Com _-modules	66
5.5.1 Ekip Com Modbus RTU -module	66
5.5.2 Ekip Com Profibus DP -module	69
5.5.3 Ekip Com DeviceNet -module	72
5.5.4 Ekip Com Modbus TCP -module	76
5.5.5 Ekip Com Profinet -module	80
5.5.6 Ekip Com EtherNet/IP -module	83

6. Troubleshooting 87

6.1 Alarms	87
6.2 Warnings	89
6.3 Information	90

7. Technical data	91
7.1 General technical data	91
7.2 Circuit diagrams	94
7.3 Overall dimensions	96
8. Maintenance	99
9. Panel installation	101
9.1 Basic Tools for Installation and Maintenance	102
9.2 Equipment Inspection and Storage	102
9.3 Lifting and mounting the panel	103
9.4 Mounting the automatic transfer switch	104
9.4.1 Mounting hole dimensions	104
9.4.2 HMI installation	105
9.5 Wire connection	106
9.6 Final Equipment Inspection	106
9.7 Initial Energizing	107
10. Accessories	109
10.1 Phase barriers	109
10.2 Auxiliary contact blocks	110
10.3 Auxiliary power supply and Ekip -modules	111
10.4 HMI protective cover	113
11. Replacement parts	115



1

1. Introduction

This manual describes the installation, basic operation, and maintenance of the Zenith ZTS(D) T-series (30-1200A, 200-480Vac) automatic transfer switches, manufactured by ABB. Installation instructions for the transfer switch and available accessories can be found in chapters 9 and 10.

1.1 Hazard Categories

The following important highlighted information appears throughout this document to warn of potential hazards or to call attention to information that clarifies a procedure.

Carefully read all instructions and become familiar with the devices before trying to install, operate, service or maintain this equipment.

**Danger**

Indicates a hazardous situation that, if not avoided, will result in death or serious injury.

**Warning**

Indicates a hazardous situation that, if not avoided, could result in death or serious injury.

**Caution**

Indicates a hazardous situation that, if not avoided, could result in minor or moderate injury. Failure to comply with these instructions may result in product damage.

**Notice**

It is used to notify of practices not related to personal injury. Failure to comply with these instructions may result in product damage.

1.2 Definitions

ATS

Automatic transfer switches

Ekip

Electronic accessories / Ekip-modules; communication, signaling and connectivity modules

HMI

Control interface (Human Machine Interface), operating and configuration

Programming port

Only for Ekip Programming and Ekip Bluetooth -modules (USB port)

Slide switch

Switch for operating mode selection (Hand - Locking - AUTO)

S1

SOURCE 1, power supply

S2

SOURCE 2, power supply

Zenith ZTS T-series ATS

Business, industrial and Mission critical enclosed automatic transfer switches, product name

Load Shed

Digital output function for signaling a downstream load to disconnect. This functionality is different than the legacy Zenith R15 Load Shed which is an input for the ATS to disconnect generator when signaled.

1.3 Warranty

This document is based on information available at the time of its publication. While efforts have been made to ensure accuracy, the information contained herein does not cover all details or variations in hardware and software, nor does it provide for every possible contingency in connection with installation, operation, and maintenance. Features may be described herein that are not present in all hardware and software systems.

ABB Zenith assumes no obligation of notice to holders of this document with respect to changes subsequently made. ABB Zenith makes no representation or warranty, expressed, implied, or statutory, and assumes no responsibility for the accuracy, completeness, sufficiency, or usefulness of the information contained herein. No warranties of merchantability or fitness for purpose shall apply.

Contact your local sales office if further information is required concerning any aspect of the automatic transfer switch operation or maintenance.

Warranty Period

The Warranty Period for ZTS T-series transfer switch products is twenty-four (24) months from the date of shipment.

Notes: This warranty is valid only in the United States and for products sold and installed within seller-specified countries.

Replacement parts are warranted for a period of 90 days when installed by a factory or an authorized service station.

Contact Service team at: +1 800 637 1738 or epis.pqs-service@abb.com for 24-hour support.

1.4 Product Specification

Quality Assurance

All ABB Zenith automatic transfer switches have been designed and manufactured to the highest technical standards. Strict procedures ensure first-class product quality.

Product Serial Number

Please have the serial number available when communicating about the automatic transfer switch. The serial number can be found on the product nameplate affixed to each power panel assembly. See example below.

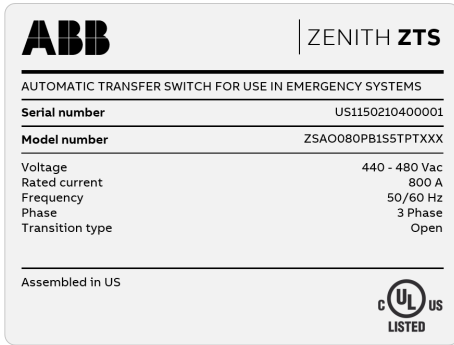

Figure 1.1: Sample nameplate

Product Rating / Applicable Standards

For UL 1008 ‘withstand’ and ‘close on short circuit’ ratings, refer to ABB publication number 1SCC303020C0201.

2. Product overview

Zenith ZTS T-series automatic transfer switches, from 30 A up to 1200 A, are designed for use in Business, industrial and Mission critical low voltage automatic transfer switch applications. Zenith ZTS T-series automatic transfer switches can be operated electrically by touch screen control interface (HMI) or manually by using the handle. You can select the operating mode by the slide switch (Hand - Locking - AUTO) on switch front. Configuration is done by LCD HMI.

The available operation types for automatic transfer switches:

- Open (standard) transition Zenith ZTS T-series ATS, type codes beginning ZSO_from 30-1200 A, 200-480 Vac
- Delayed transition Zenith ZTSD T-series ATS, type codes beginning ZSD_from 30-1200 A, 200-480 Vac

2.1 General overview

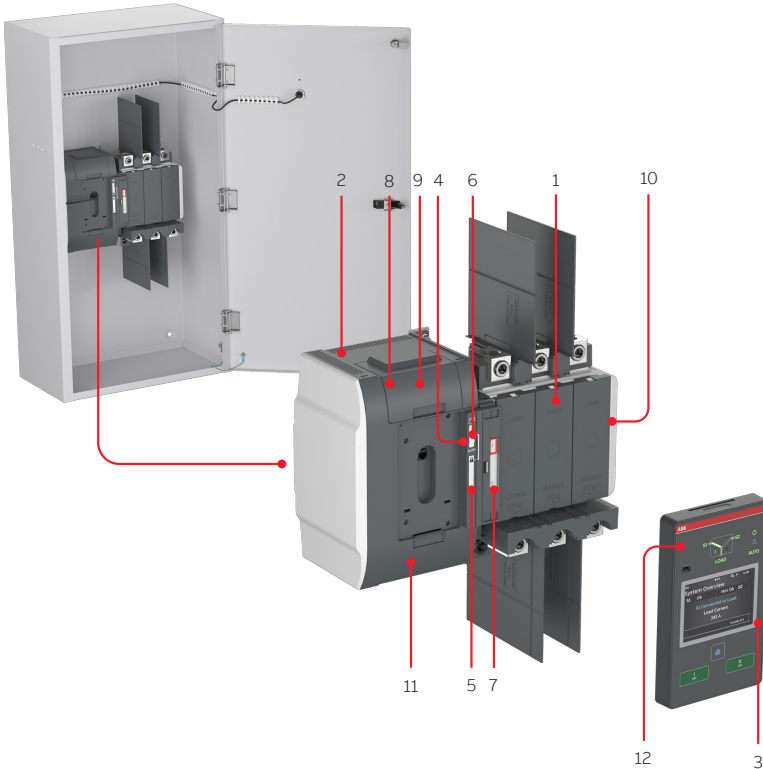

Fig. 2.1 Automatic transfer switch, Zenith ZTS powered by TrueONE™

- 1 Automatic transfer switch
- 2 Embedded ATS control unit and mechanism
- 3 Level 4 HMI unit, ZTS T-series color touchscreen LCD
- 4 Slide switch (Hand - Locking - AUTO) for selection of the operation mode
- 5 Padlocking the automatic transfer switch to prevent automatic and manual operation
- 6 Handle for manual operation
- 7 Position indication
- 8 Terminals for control circuit connections (behind the cover)
- 9 Place for connectivity modules (aux power supply, com and signaling)
- 10 Place for auxiliary contact block
- 11 Location of product identification label
- 12 Programming port, only for Ekip Programming module and Ekip Connect software

2.1.1 Operation types

In this table you can find the differences of the automatic transfer switch open and delayed transition operation types. Due to the different transition types, there are variances with HMI and on wiring of I/O contacts. For more information on HMIs, see chapter 2.2.





Operation types, ZTS T-series ATS		Ekkip-modules suitable
Delayed transition, ZTSD S1 I O II S2  Load	Open transition, ZTS S1 I II S2  Load	
ZTS T-series HMI (with touch screen) and connections of control circuit		
		Suitable 
		

Table 2.1 The differences of level types / operation types and the suitability of Ekkip-modules

2.2 HMI

The HMI is the control interface (Human Machine Interface) of the ATS.

Zenith ZTS T-series has a color touch-screen LCD HMI with push buttons. The HMI is used for configuring parameters for automatic operation.

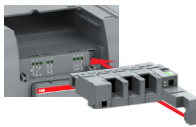
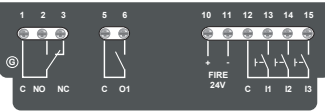
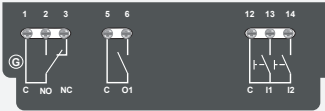
ZTS:
HMI with
Touch screen

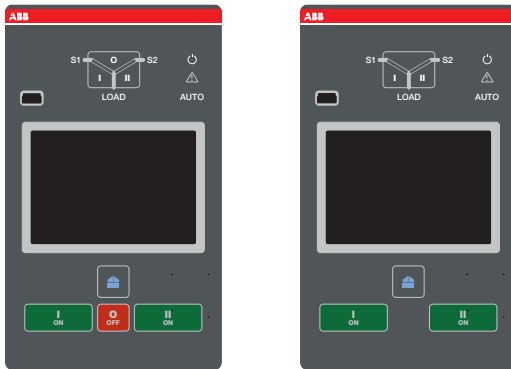

I - O - II (or II - O - I)

Fig. 2.2 The HMI form will correspond to the type of ZTS T-series - open or delayed transition

2.3 Zenith ZTS(D) T-series features

Feature comparison

ZTS(D) controls (Touch screen)

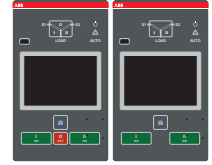

Ampere sizes available	UL: 30-1200 A
Rated voltage	200-480 Vac
Rated frequency	50 / 60 Hz
Phase system	Single and Three
Number of poles	3 and 4
Neutral configuration	
Switched	Yes
Product type	
Open transition (I-II)	Yes
Delayed transition (I - O - II or II - O - I)	Yes
Voltage and frequency settings	
Pick up SOURCE 1 Voltage	71-99 %, 101-119 %
Drop out SOURCE 1 Voltage	70-98 %, 102-120 %
Pick up SOURCE 2 Voltage	71-99 %, 101-119 %
Drop out SOURCE 2 Voltage	70-98 %, 102-120 %
Pick up SOURCE 1 Frequency	80.5-99.5 %, 100.5-119.5 %
Drop out SOURCE 1 Frequency	80-99 %, 101-120 %
Pick up SOURCE 2 Frequency	80.5-99.5 %, 100.5-119.5 %
Drop out SOURCE 2 Frequency	80-99 %, 101-120 %
Time delay settings	
Override momentary SOURCE 1 Outage, sec	0-60
Transfer from SOURCE 1 to SOURCE 2, sec	0-3600
Override momentary SOURCE 2 Outage, sec	0-60

Feature comparison

ZTS(D) controls (Touch screen)

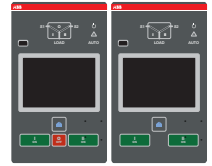

Transfer from SOURCE 2 to SOURCE 1, min	0-120
Generator stop delay, min	0-60
Center-OFF delay, sec	0-300
Pre-transfer delay S1 to S2, sec	0-300
Post-transfer delay S1 to S2, sec	0-300
Pre-transfer delay S2 to S1, sec	0-300
Post-transfer delay S2 to S1, sec	0-300
Elevator Pre-signal delay S1 to S2, sec	0-60
Elevator Post-signal delay S1 to S2, sec	0-60
Elevator Pre-signal delay S2 to S1, sec	0-60
Elevator Post-signal delay S2 to S1, sec	0-60
Load shed delay, sec	0-60
Source failure detections	
No voltage	Yes
Undervoltage	Yes
Overvoltage	Yes
Phase missing	Yes
Voltage unbalance	Yes
Invalid frequency	Yes
Incorrect phase sequence	Yes
Features	
Controls	Touch + keys
LED indications for ATS, S1 and S2 status	Yes
Open transition - Standard digital inputs/outputs	2 / 1
Delayed transition - Standard digital inputs/outputs	3 / 1
Programmable digital inputs/outputs	Yes
Auto config (voltage, frequency, phase system)	Yes

Feature comparison

ZTS(D) controls (Touch screen)

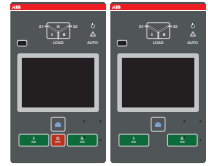

Auto config (voltage frequency, phase system)		Yes
Source priority	SOURCE 1/2, No priority	
Manual re-transfer		Yes
In-phase monitor		Yes
Genset exercising: on-load, off-load		Yes
In-built power meter module		Yes
Load shedding		Yes
Real time clock		Yes
Event log		Yes
Predictive maintenance		Yes
Harmonics measuring	Voltage, current	
Field-mount accessories		
Auxiliary contacts for position indication		Yes
Digital input/output modules		Yes
12-24 Vdc aux supply module for controller		Yes
Communication modules		Yes
Connectivity		
Modbus RS485		Yes
Modbus/TCP		Yes
Profibus DP		Yes
ProfiNet		Yes
DeviceNet		Yes
Ethernet IP		Yes
Ekip Com Hub (monitoring via ABB Ability™: EDCS)		Yes
Enclosures		
Type 1, 3R, 4, 12, and 4X		Yes
For applications		
Mains - Mains		Yes
Mains - Generator ¹⁾		Yes

¹⁾ Contact ABB for applications with smaller than 20 KVA gensets.

Table 2.2 ATS features not limited to what is in the table above

2.4 Typical applications

Zenith ZTS T-series automatic transfer switches from 30 A up to 1200 A, are designed for use in emergency or standby systems to choose and to switch between two power sources. See possible supply phase scenarios on next page. You have to define your own supply phase system - reference Chapter 4 / Navigating menu / Parameters: Power distribution systems. Factory setting: 3 phases with neutral.

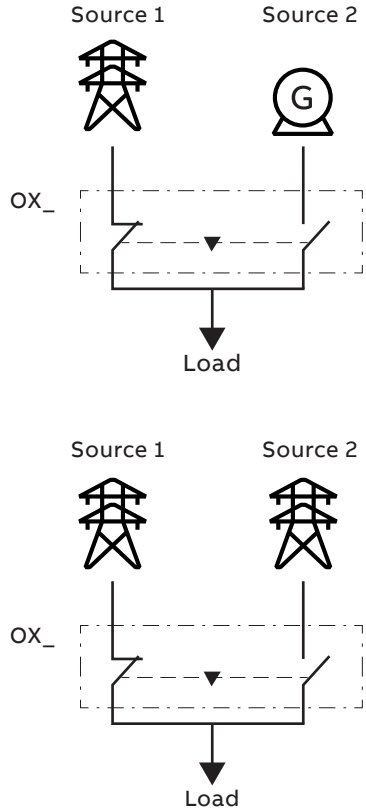
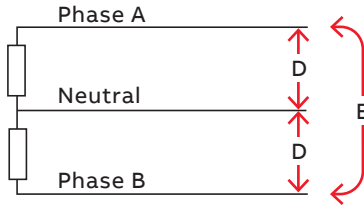
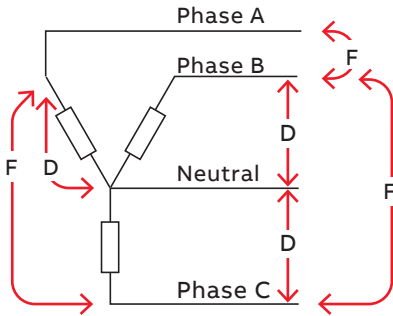

Fig. 2.3 Typical applications of automatic transfer switches



Single-phase, three-wire



Three-phase, four-wire

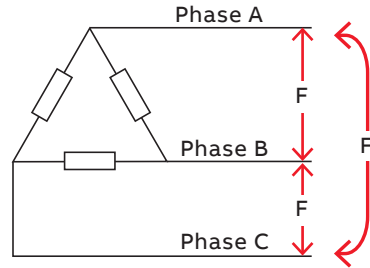

Three-phase, three-wire

D	E	F
200-480 Vac L-N	200-480 Vac L-L	200-480 Vac L-L

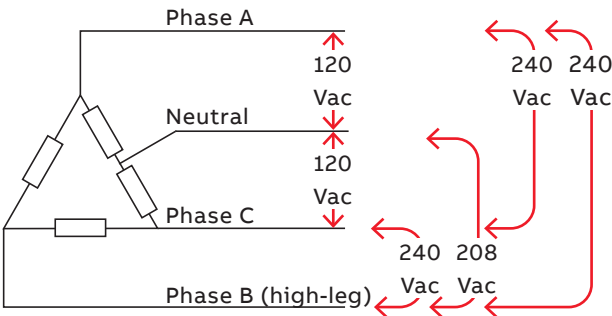

Three-phase, with high leg delta

A07482

Fig. 2.4 Possible supply phase scenarios

2.5 Sequence of Operations

2.5.1 Switching sequence / Automatic

2.5.1.1 SOURCE 1 Priority (SOURCE 2 = Generator)

The switching sequence can be summarized in the following steps:

1. An anomaly occurs on SOURCE 1
2. Override momentary S1 outage delay
3. Generator start
4. SOURCE 2 OK
5. Transfer from S1 to S2 delay
6. Pre-transfer signal on
7. Load shed signal on
8. Pre-transfer S1 to S2 delay
9. Load shed delay
10. Transfer switch (SOURCE 1) to position O
11. Center-off delay (only with Delayed transition I - O - II type)
12. Transfer switch (SOURCE 2) to position II
13. Post-transfer S1 to S2 delay
14. Pre-transfer signal off

The re-transfer sequence can be summarized in the following steps:

1. SOURCE 1 is restored
2. Transfer from S2 to S1 delay
3. Pre-transfer signal on
4. Pre-transfer S2 to S1 delay
5. Transfer switch (SOURCE 2) to position O
6. Center-off delay (only with Delayed transition I - O - II type)
7. Transfer switch (SOURCE 1) to position I
8. Load shed signal off
9. Generator stop delay
10. Post-transfer S2 to S1 delay
11. Pre-transfer signal off
12. Generator stop
13. SOURCE 2 off

SOURCE 1 priority (SOURCE 2 = generator)

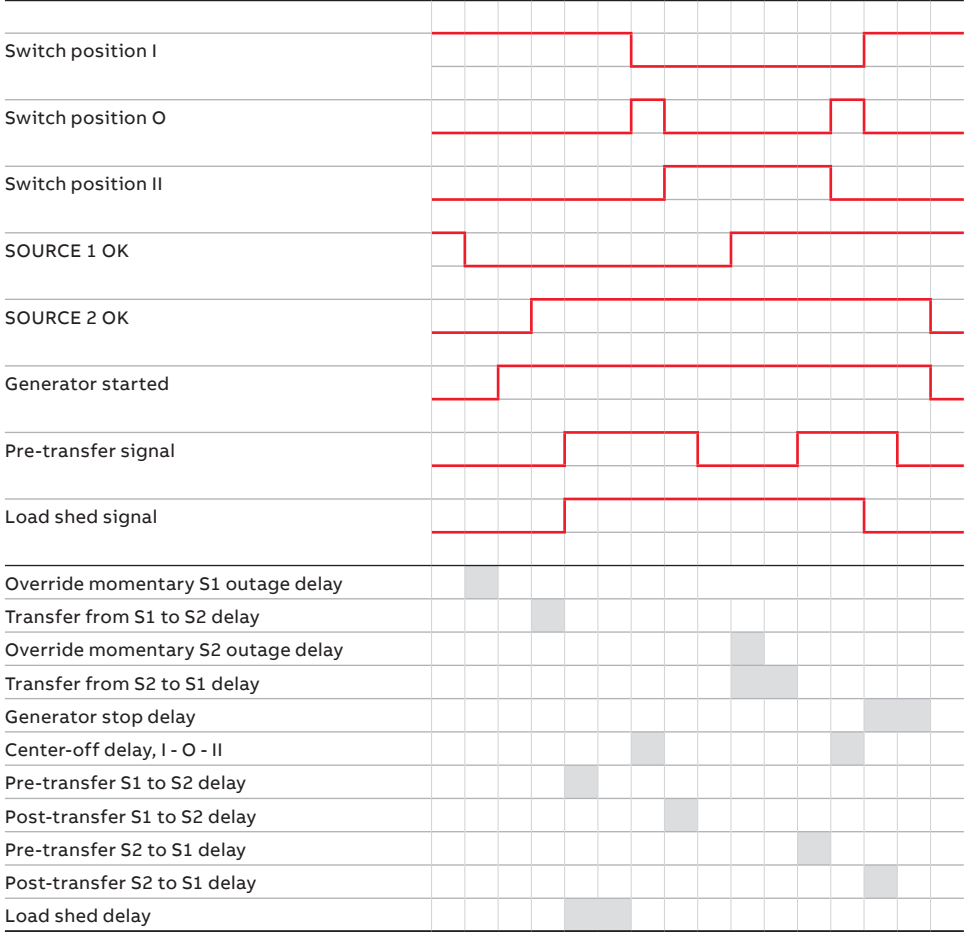

Table 2.3 Automatic Switching Sequences, SOURCE 1 Priority (SOURCE 2 = Generator)

2.5.1.2 SOURCE 2 Priority (No generator)

The switching sequence can be summarized in the following steps:

1. An anomaly occurs on SOURCE 2
2. Override momentary S2 outage delay
3. Transfer from S2 to S1 delay
4. Pre-transfer signal on
5. Load shed signal on
6. Pre-transfer S2 to S1 delay
7. Load shed delay
8. Transfer switch (SOURCE 2) to position O
9. Center-off delay (only with Delayed transition I - O - II type)
10. Transfer switch (SOURCE 1) to position I
11. Post-transfer S2 to S1 delay
12. Pre-transfer signal off

And the re-transfer sequence can be summarized in the following steps:

1. SOURCE 2 is restored
2. Transfer from S1 to S2 delay
3. Pre-transfer signal on
4. Pre-transfer S1 to S2 delay
5. Transfer switch (SOURCE 1) to position O
6. Center-off delay (only with Delayed transition I - O - II type)
7. Transfer switch (SOURCE 2) to position I
8. Load shed signal off
9. Post-transfer S1 to S2 delay
10. Pre-transfer signal off

SOURCE 2 priority (no generator)

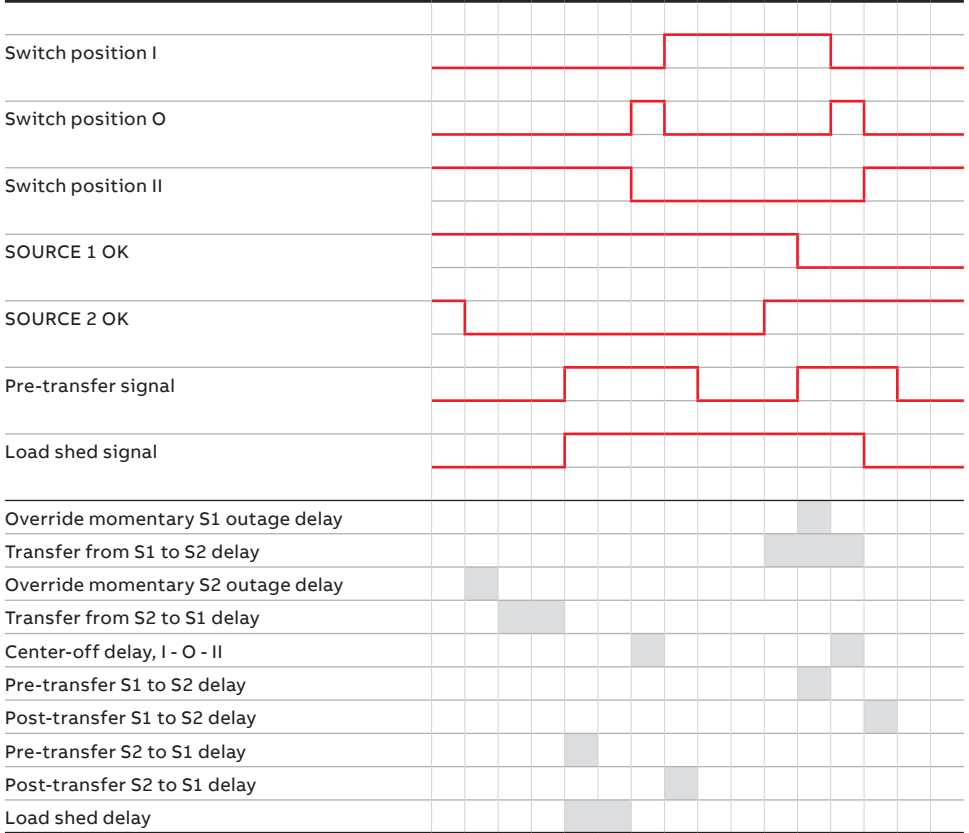

Table 2.4 Automatic Switching Sequences, SOURCE 2 Priority (No generator)

2.5.1.3 No Source Priority (Generator and load shed usage disabled)

The switching to available source can be summarized in the following steps:

1. An anomaly occurs on SOURCE 1
2. Override momentary S1 outage delay
3. Pre-transfer signal on
4. Pre-transfer S1 to S2 delay
5. Transfer switch (SOURCE 1) to position O
6. Center-off delay (only with Delayed transition I - O - II type)
7. Transfer switch (SOURCE 2) to position II
8. Post-transfer S1 to S2 delay
9. Pre-transfer signal off

When an anomaly occurs in the source in-use, the re-transfer to available source can be summarized in the following steps:

1. SOURCE 1 is restored
2. An anomaly occurs on the SOURCE 2
3. Pre-transfer signal on
4. Pre-transfer S2 to S1 delay
5. Transfer switch (SOURCE 2) to position O
6. Center-off delay (only with Delayed transition I - O - II type)
7. Transfer switch (SOURCE 1) to position I
8. Post-transfer S2 to S1 delay
9. Pre-transfer signal off

No source priority (generator and load shed usage disabled)

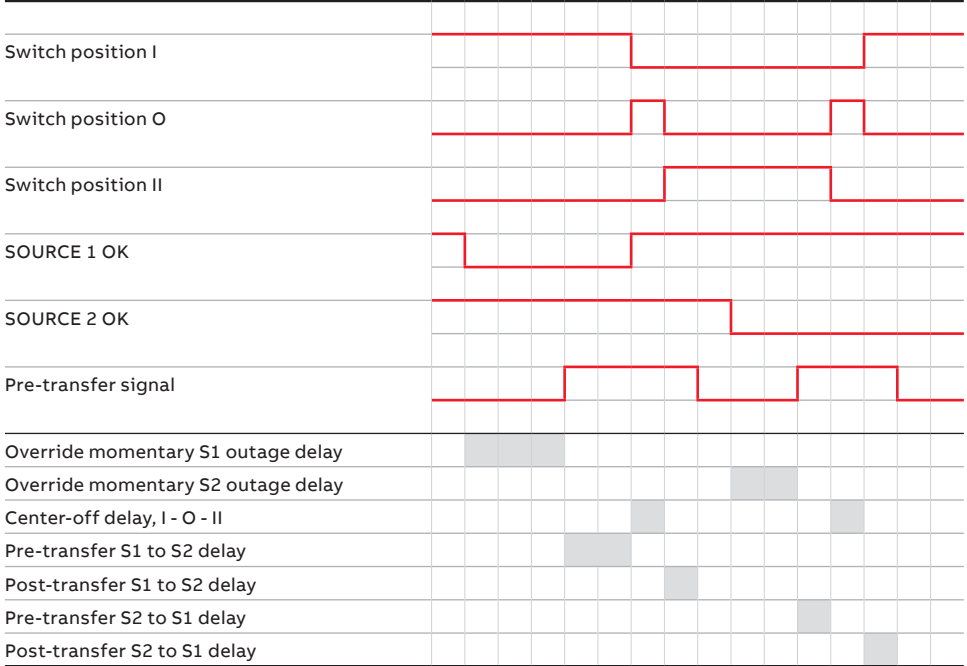

Table 2.5 Automatic Switching Sequences, No Source Priority (Generator and load shed usage disabled)

2.6 Special features description

2.6.1 Automatic configuration

Basic system parameters can be automatically configured from the HMI: rated voltage, rated frequency, each supply power distribution system type, and neutral location will be recognized and set by the controller. Other parameters are set to factory values; see Chapter 4, Navigating menu.

2.6.2 In-phase monitor

In-phase monitor is a feature that calculates the phase difference of supply lines, preventing transfer when sources are not in sync. The user can set On/Off from the HMI. When the in-phase monitor is set to On, the device measures and detects when both sources are in sync with each other. The ATS will allow transfer from SOURCE 1 (S1) to SOURCE 2 (S2) only when they are in sync with each other. Any of these conditions will prevent source transfer when In-phase monitor is set to On:

- Phase difference between sources remains greater than 5 degrees
- Phase order between sources is not the same
- Voltage amplitude is out of range
- Phase is missing
- Voltage is asymmetric
- Frequency is out of range

2.6.3 Powering supply scenarios

Device can be powered by the the following methods:

- Direct from SOURCE 1 or SOURCE 2: Controller and HMI are powered and ATS can be operated electrically.
- Auxiliary power supply module, OXE1: Controller and HMI are powered, but load transfer cannot be performed.
- Programming port on HMI (USB port): Only the main board is powered. Allows software update to main device and connection of Ekip Connect commissioning tool.

3. General operation

3.1 Position indication

Contact movement and position indication is indicated in the figure below, on left side: Open transition I - II (or II - I) and on right side: Delayed transition I - O - II (or II - O - I)

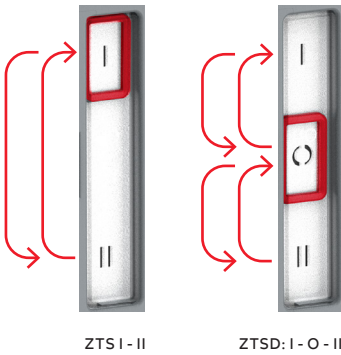

Fig. 3.1 Contact movement / position indication:
Type ZTS, Open transition; Type ZTSD, Delayed transition

3.2 Operating and locking

The operation mode is selected by using the slide switch (Hand - Locking - AUTO) located on the front of the automatic transfer switch (ATS).

- **Hand-position = Manual mode**, enabling emergency manual operation using the handle. ATS functionality is disabled when in Hand position.
- **Lock-position = Locking mode**, padlocking the automatic transfer switch in a specific position to prevent automatic and manual operation.



Manual mode

Automatic mode

Notice
 The handle has to be in its stored position (not in use), after which the slide switch will move to the Locking mode automatically and the switch is allowed to be padlocked. To set the operating handle back to its place, refer to the left most picture in Fig. 3.6.

- **AUTO-position = Automatic control mode enabled**, ATS is operable in Automatic mode or from the HMI manual control keys. When the slide switch is moved to the AUTO position, the ATS is functioning immediately in the automatic control mode.

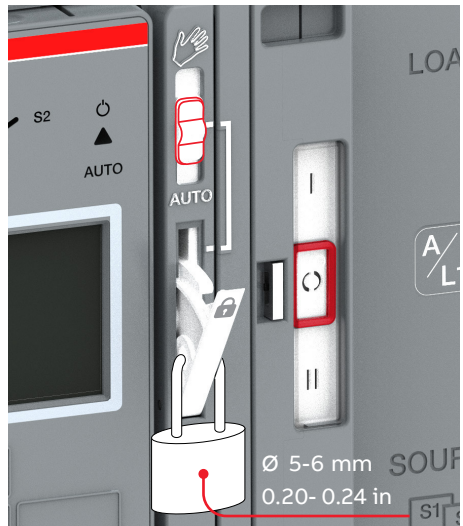

Locking mode

Fig. 3.2 Above the selection of the operation modes (Manual or Automatic) by the slide switch. Below padlocking the automatic transfer switch; The handle has to set standby slot (not in use), after that the slide switch will move to the Locking mode automatically and the switch is allowed to be padlocked.

3.3 Manual handle operation



Warning

Verify the condition of power source prior to manually transferring. Manual operation may result in out-of-phase transfer when both sources are energized.

To mount the handle in the operating position, turn the slide switch to the Manual mode (Hand), lift the handle from its place inside and place it to the operating position.

More information, see animation: Manual and automatic operation - TruONE™ ATS (<https://youtu.be/bosvSPVi2sM>).



Fig. 3.3 Mounting of the handle in the operating position

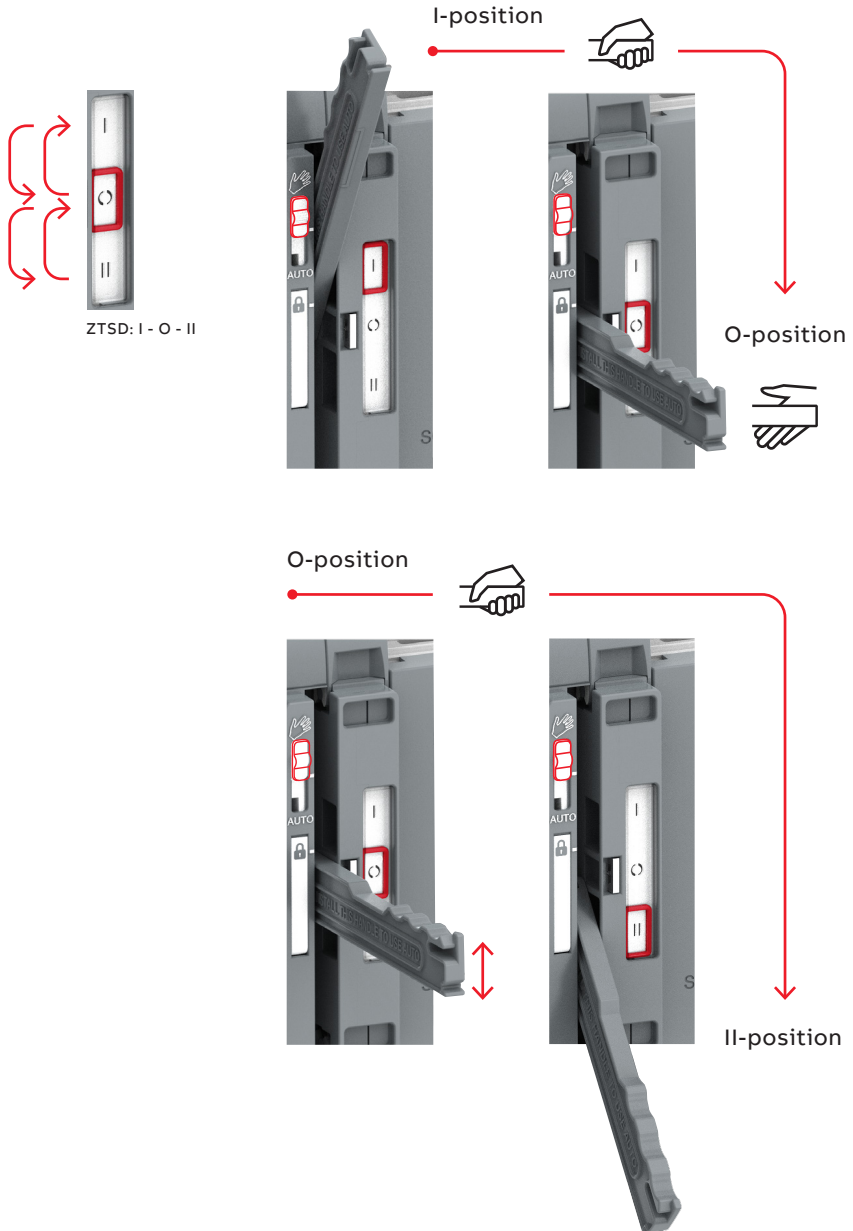

Fig. 3.4 Manual mode, operating by handle, delayed transition I - O - II. You have to stop and release (= take the hand off) the handle in O-position when moving from position I to II (or from position II to I)

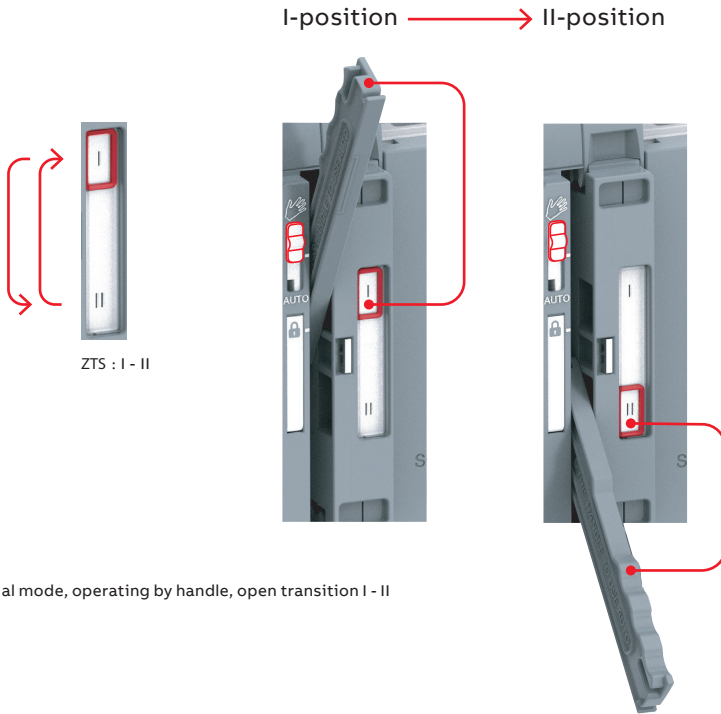

Fig. 3.5 Manual mode, operating by handle, open transition I - II

3.4 Return to Automatic mode, operating by HMI

When operating the automatic transfer switch by HMI, turn the slide switch to Automatic mode (AUTO). Remark! The handle has to be standby slot (not in use) before turning to automatic mode.



Notice

When the slide switch is moved to the AUTO position, the ATS will enter auto mode after a 3 second delay.

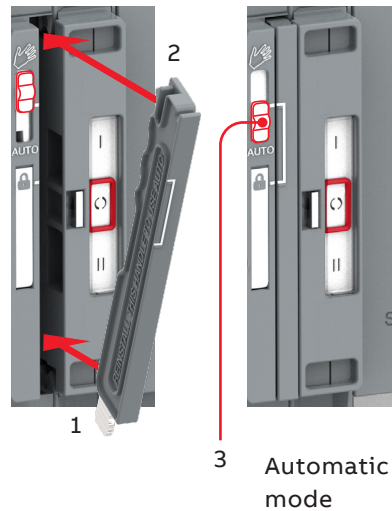

Fig. 3.6 The operating handle must set back to standby slot before moving to the automatic mode

3.5 LED functionality in HMI

At the top of ZTS 30-1200 A, 200-480 Vac ATS, there is a set of LEDs intended to model the state of the transfer switch sources, position, alarms, and mode. A considerable amount of information can be deciphered from the LED states. See the tables below for more information.

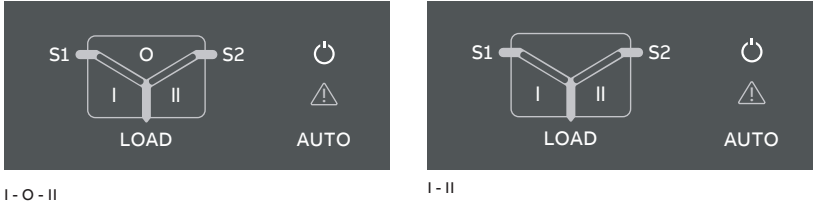
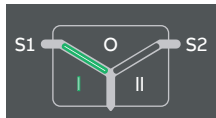

Fig. 3.7 On left: LEDs in ZTSD, delayed transition, I - O - II. On right: LEDs in ZTS, open transition I - II.

LED	Indication	Description
Power led		
	ON, fixed light	Power supply and communication present
	2 quick flashes/1 s	Power supply present, communication absent between switch and the HMI
	OFF	No power available for HMI.
S1 and S2 leds		
	ON, fixed light	S1 or / and S2 is present and within user defined limits
	2 quick flashes/1 s	Undervoltage
	Flash/1 s, 90 %/10 %	Invalid frequency
	Flash/1 s, 10 %/90 %	Unbalance
	5 flashes/1 s, 50 %/50 %	Overvoltage
	Flash/2 s, 50 %/50 %	Incorrect phase sequence
	Flash/4 s, 50 %/50 %	Phase missing
	Flash/1 s, 50 %/50 %	Generator stop delay ongoing
OFF	No voltage	

I, II and O leds



ON, fixed light 

Switch position is indicated with fixed light in I, O or II led. Only one can be on simultaneously



Flash/1 s, 50 %/50 % 

Delay ongoing. Going to move away from the blinking status

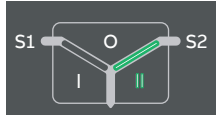

Load led



ON 

Supply ok and connected to load

OFF 

Not connected to load

Auto led



ON, fixed light 

Switch is in automatic mode

Flash/1 s, 50 %/50 % 

Test on load

Flash/1 s, 90 %/10 % 

Test off load

Flash/1 s, 10 %/90 % 

If blinks simultaneously with Alarm led then 'Remote control to S1', 'Remote control to S2', 'Remote control to OFF' or 'Inhibit transfer' digital input is activated.

5 flashes/1 s, 50 %/50 % 

Autoconfig completed

Alarm led



OFF 

No alarms

ON, fixed light 

Handle attached, locked, other alarm

2 quick flashes/1s 

Control Alarm

5 flashes/1 s, 50 %/50 % 

Auto configuration ongoing

Flash/1 s, 50 %/50 % 

Control Retry

Flash/1 s, 10 %/90 % 

Auto mode off

Flash/1 s, 10%/90 % 

If blinks simultaneously with Alarm led then 'Remote control to S1', 'Remote control to S2', 'Remote control to OFF' or 'Inhibit transfer' digital input is activated. If Auto led is fixed light then manual retransfer is required.

Table 3.1 LED functionality

3.6 Using Level 4 (touch) control interface HMI

3.6.1 Keypad

- 1 **Home Button:** Opens up the root menu or brings user to the homepage if defined. While viewing a specific page, it can be defined as the home page by pressing the home button for 3 seconds. All pages, except for the menus, can be set as home page. Home page is automatically shown after inactivity.
- 2 **I ON:** Operate switch to I position.
- 3 **II ON:** Operate switch to II position.
- 4 **O OFF:** Operate switch to O position and disable automatic control mode (only in delayed transition I-O-II type).

3.6.2 Navigating in menu

See the menu tree in Chapter 4.

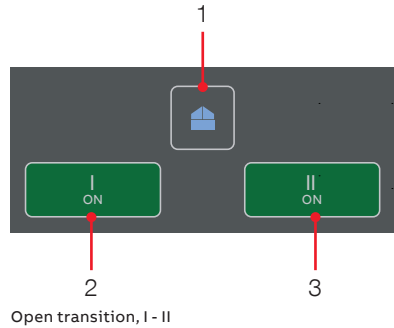
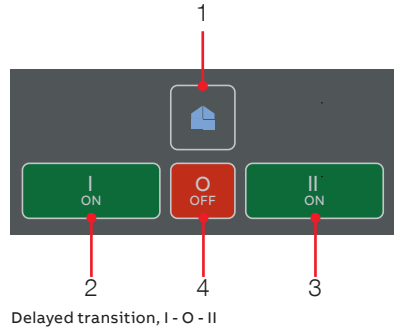

Fig. 3.8 Keypad in Level 4 HMI with touch screen

4. Navigating HMI menu

4.1 Start Menu

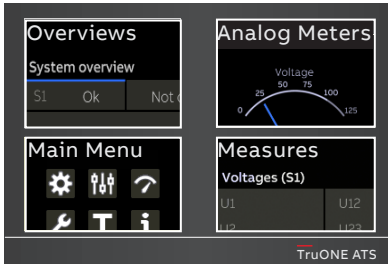

Fig. 4.1

Fig. 4.1 By touching on one of Start Menu choices, you can choose the Overviews -pages (upper left corner), Main Menu -pages (lower left corner), Analog Meters -pages (upper right corner) or Measures -pages (lower right corner)

Fig. 4.2 By touching on Start Menu upper left corner -image you can move to the Overviews -pages, where you will find Switch status and Supply info views, see the table below

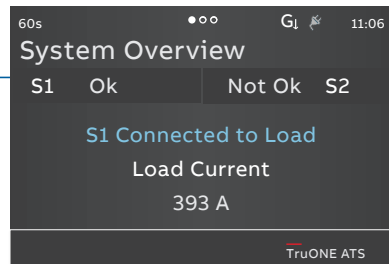
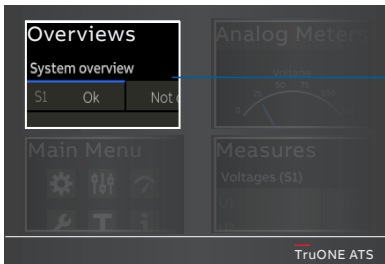

Fig. 4.2

System Overview (Switch status)

Shows voltages and frequencies of both supplies and the switch position.

Supply info view

Shows voltages and frequencies of both supplies.

Temperature view

Shows the HMI, device and pole temperatures.

HMI temperature indicates ambient temperature where the ATS power panel is installed, when HMI is mounted to door.

Device temperature indicates the temperature inside the ATS power panel.

Pole temperature indicates the temperature on the load side terminals.

Synchronization view (Enabled only when In-phase monitor is on)

Show the time to next sync, sync period.

Alarm List

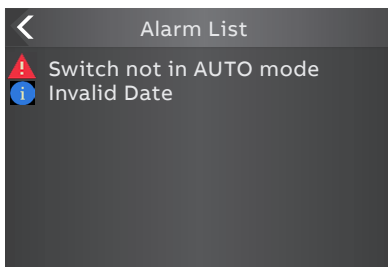

Fig. 4.3
By touching on the alarm indication on the lower edge of the screen you will get the Alarm List.

Description of the icons

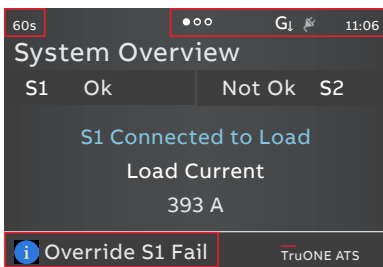

Fig. 4.4
The location of the small icons and the alarms.

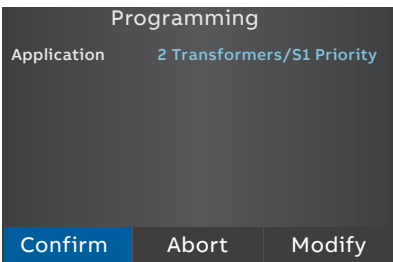

Fig. 4.5
After you have changed the parameter, go back in the menu by pressing the < on the top left corner or Home key and when prompted confirm changes by Confirm option.

On the lower edge of the screen you can see the Alarms. If you touch on the alarm you will get the Alarm List.



Notice
When a parameter is changed, always go back in the menu by pressing the home button and confirm the change when asked.

For more information, see chapter 6, Troubleshooting.

The small icons in System Overview -pages are:

On upper right corner

● ○ ○ ○ Indicates the amount of pages and the page where you are at the moment

 Auxiliary voltage connected

11:06 Time

 Application set up as Transformer-Generator. Generator start-up signal deactivated

 Application set up as Transformer-Generator. Generator start-up signal activated

On upper left corner

60s Time delay, in Alarm list you can see the name of delay at the same time, e.g. Override S1 Fail

4.2 Using main menu and setting parameters

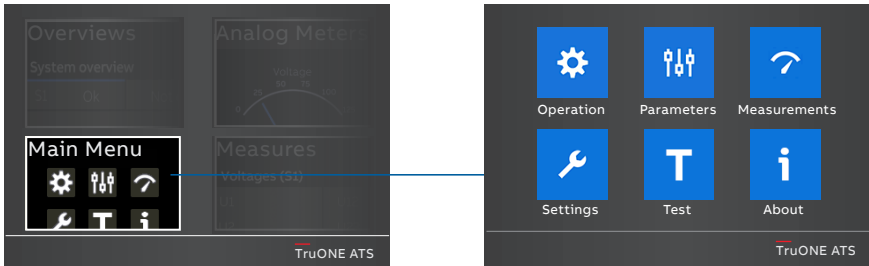

Fig. 4.6

By touching on Start Menu lower left corner -image you can move to the Main Menu page of Operation, Parameters, Measurements, Settings, Test and About, see the table below for the selections.



Information

When you have changed the parameter, go always back in the menu and confirm the change always when asked.



Information

The default values are marked in the menu tree by *-marking.

Password

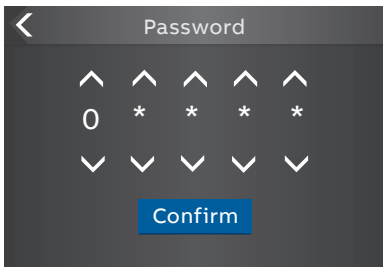
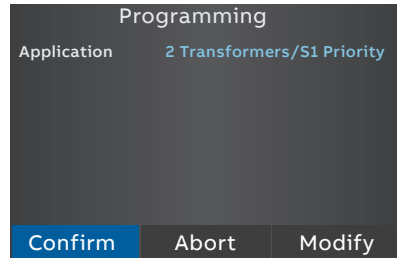



Fig. 4.7

Enter the password when asked, choose the right number by arrowheads and confirm, go forward entering number after number.



The default password is 00001, enter the password when prompted (see Fig. 4.1).

4.3 Menus and parameters

Operation		*Default
	Alarm Reset	Reset any active switch control alarms (open I failure, close I failure, open II failure, close II failure)
	Bypass Time Delay	Bypass any currently running time delay
	HMI Control Keys ¹⁾	Enabled* Disabled
	Energy Counters	Reset energy values
	Operation mode	AUTO* Automatic switch control mode. ²⁾ MAN Momentary Manual operation mode but warning that device is in manual mode will be shown by HMI. ATS will automatically send and remove the generator start signal but user intervention is required to initiate transfer and retransfer. MAN Permanent Manual operation mode but no manual mode warnings are shown by HMI. ATS will automatically send and remove the generator start signal but user intervention is required to initiate transfer and retransfer. MAN retransfer Same as Automatic Operation Mode but automatic retransfer sequence is disabled. Load will be kept on non-priority source until operator manually (by HMI or manual handle) or remotely operates the load back to priority source.

¹⁾ Note: Disables also 0-key in Delayed Transition models!

²⁾ Note: When automatic mode parameter is confirmed there is 3 second delay before entering it.

Parameters	*Default
 System parameters	
Start Automatic Configuration	
Power distribution systems (see Fig. 2.2)	
Source 1	1 Phase, 2 Wire
	1 Phase, 3 Wire (Split-Phase)
	3 Phases, no Neutral (3ph3w)
	3 Phase with Neutral (3ph4w)*
	3 Phase, High-Leg Delta
Source 2	1 Phase, 2 Wire
	1 Phase, 3 Wire (Split-Phase)
	3 Phases, no Neutral (3ph3w)
	3 Phase with Neutral (3ph4w)*
	3 Phase, High-Leg Delta
Rated Voltage	
200 V (3ph), 208 V (3ph), 220 V (3ph), 230 V (3ph), 240 V (3ph), 277 V (3ph), 347 V (3ph), 380 V (3ph), 400 V (3ph)* , 415 V (3ph), 440 V (3ph), 460 V (3ph), 480 V (3ph), 200 V (1ph), 220 V (1ph), 230 V (1ph), 240 V (1ph)	
Rated Frequency	
50 Hz*	
60 Hz	
Neutral Pole Location	
Pole 4* ¹⁾	
Pole 1	
Phase Sequence	
ABC*	
ACB	
Not Enabled	

¹⁾ Overlapping neutral always on Pole 4, this cannot be changed.

Continued on the next page

Parameters (continued)		*Default
Device Parameters		
In-phase Monitor		
Enable	Off*	
	On	
Synchronization Window	±1...10 % (±1* %)	A phase angle difference limits to restrict live to live source transfers unless both sources are within this certain window of electrical degrees.
Time Delays		
Override S1 Failure	0...60 s (2* s)	S1 priority: How long the device is waiting S1 recovery before starting transfer sequence to S2. S2 priority: How long the device is keeping the load on failed S1 although S2 is already available.
Transfer from S1 to S2	0...60 min (2* s)	S1 priority: How long the device is keeping the load on failed S1 after S2 becomes available. S2 priority: How long the device waits before transfer sequence back to available S2 begins. This delay is bypassed by 'Override S1 Failure' in case of S1 failure.
Pre-transfer signal 1 / 2 / 3 / 4		
Pre-transfer S1 to S2 Post-transfer S1 to S2 Pre-transfer S2 to S1 Post-transfer S2 to S1	0*...300 s	Enabled only when any digital outputs is configured as 'Pre-transfer Signal'. Pre-transfer: How long the device is keeping pre-transfer signal activated before transferring from S1 to S2 or S2 to S1. Post-transfer: How long the device is keeping pre-transfer signal activated after transferring from S1 to S2 or S2 to S1.
Center-Off	0*...300 s	Only delayed transition I-O-II type. How long the switch is stopped at position O while transferring from S1 to S2 or from S2 to S1 and the original source is not completely down. Center-OFF delay is bypassed in case all phases are missing from the original source which we are leaving.

Continued on the next page

Parameters (continued)

*Default



Device Parameters (continued)

Time Delays (continued)

Override S2 Failure	0...60 s (2* s)	S1 priority: How long the device is keeping the load on failed S2 although S1 is already available. S2 priority: How long the device is waiting S2 recovery before starting transfer sequence to S1.
Transfer from S2 to S1	0...120 min (2* s)	S1 priority: How long the device waits before transfer sequence back to available S1 begins. This delay is overridden by 'Override S2 Failure' in case of S2 failure. S2 priority: How long the device is keeping the load on failed S2 although S1 is already available.
Elevator Pre-transfer signal 1 / 2 / 3 / 4		
Elevator Pre-signal S1-S2	0*...60 s	Enabled only when any digital output is configured as 'Elevator pre-signal'.
Elevator Post-signal S1-S2		Pre-transfer: How long the device is keeping pre-signal activated before transferring from S1 to S2 or from S2 to S1. Post-transfer: How long the device is keeping pre-signal activated after transferring from S1 to S2 or from S2 to S1.
Elevator Pre-signal S2-S1		
Elevator Post-signal S2-S1		
Generator Stop	0...60 min (5* min)	Enabled only when generator is in use. Generator cooling time, how long the device is keeping the generator running without load after returning to priority source.
Load Shed	0*...60 s	Enabled only when any digital output is configured as 'Load Shed'. How long before the transfer from priority to non-priority source the device activates load shed signal.

Continued on the next page

Parameters (continued)	*Default	
Device Parameters (continued)		
 <p>Voltage & Frequency Setpoints</p>	<p>Defines the voltage and frequency limits for source being acceptable. Source has an anomaly when measured voltage/frequency goes out of range drop-out lower/drop-out Upper. Source becomes acceptable when measured voltage/frequency goes back in range pick-up lower/pick-up higher.</p>	
S1 Setpoints		
S1 Drop-out Voltage	Upper Threshold	102...120 % Un (115* % Un)
	Lower Threshold	70...98 % Un (85* % Un)
S1 Pick-up Voltage	Upper Threshold	101...119 % Un (114* % Un)
	Lower Threshold	71...99 % Un (86* % Un)
S1 Drop-out Frequency	Upper Threshold	101...120 % fn (115* % fn)
	Lower Threshold	80...99 % fn (85* % fn)
S1 Pick-up Frequency	Upper Threshold	100.5...119.5 % fn (114* % fn)
	Lower Threshold	80.5...99.5 % fn (86* % fn)
S2 Setpoints		
S2 Drop-out Voltage	Upper Threshold	102...120 % Un (115* % Un)
	Lower Threshold	70...98 % Un (85* % Un)
S2 Pick-up Voltage	Upper Threshold	101...119 % Un (114* % Un)
	Lower Threshold	71...99 % Un (86* % Un)
S2 Drop-out Frequency	Upper Threshold	101...120 % fn (115* % fn)
	Lower Threshold	80...99 % fn (85* % fn)
S2 Pick-up Frequency	Upper Threshold	100.5...119.5 % fn (114* % fn)
	Lower Threshold	80.5...99.5 % fn (86* % fn)

Continued on the next page

Parameters (contunued)

***Default**



Device Parameters (continued)

Generator Exercisers

Switch and generator functioning can be tested automatically and also periodically by using four independent exerciser events. Test on load function starts the generator and transfers the load to it. Test off load function only starts the generator for the duration of the event. Overlapping events are prioritized, event 1 has the highest priority.

Exerciser 1 / 2 / 3 / 4

Status

Disabled*

Non-periodic

Daily

Weekly

Bi-weekly

Monthly

Yearly

Function

No Function*

Test on Load

Test off load

Duration
(hh:mm:ss)

00:00:00...24:00:59 (00:01:00*)

Time
(hh:mm)

Starting time of the event.
00:00*...23:59

Date (month day,
year)

Starting date of the event
Jan 01, 2020... (---*)

Application

S1-Transformer/S2-Generator*

S2-Transformer/S1-Generator

2 Transformers/S1 Priority

2 Transformers/S2 Priority

2 Transformers/No Priority

Commit Transfer

Off*

If priority source fails, device cancels the transfer sequence to non-priority source (generator) if priority source returns before non-priority source becomes acceptable.

On

If priority source fails, device continues transfer sequence to non-priority source (generator) even if priority returns before non-priority souce becomes acceptable. Retransfer sequence according to time delays.

Continued on the next page

Parameters (continued)	*Default
Device Parameters (continued)	
High current alarm	
Status	
Enabled	If measured current is higher than ten times the nominal value device will prevent all operations and show high current alarm on-screen. After high current status is over, device will start operating normally.
Disabled*	
Alarm reset required	
Yes	User confirmation is required before re-entering normal operation after high current status.
No*	Normal operation is started automatically after high current status.
Transfer to Dead Source	
On*	User can transfer to an unavailable source by using HMI keys I/II or by a remote command.
Off	Transfer to an unavailable source is disabled.
Source Loss Center-Off Delay	
On*	User can select whether to always run the 'center-off' timer or skip it if there is no voltage on any of the phases on the source from where the ATS is transferring from.
Off	
Source Loss Pre-Signal Delay	
On*	User can select whether to always run the pre-signal delays 'elevator pre-signal S1-S2', 'elevator pre-signal S2-S1', 'pre-transfer S1 to S2', 'pre-transfer S2 to S1' timers or skip these if there is no voltage on any of the phases on the source from where the ATS is transferring from.
Off	

Measurements



Switch Diagnostic

Total operations	I-O-II switches: Total number of transfers I-O, O-II, II-O and O-I. I-II switches: Total number of transfers I-II and II-I
Manual operations	Total transfers operated by the handle.
Number of load transfers	Total number of transfers I-II and II-I
Transfer time	Time it took to transfer the load between sources (ms)
Source fail transfers	Total number of automatic transfers due to source failures.
Days energized	
Total time on S1	Hours
Total time on S2	Hours
Time S1 available	Minutes
Time S2 available	Minutes
Last generator start	MMM DD, YYYY hh:mm:ss
Generator starting time	How long it took for the generator to become acceptable after latest start (s).
In-phase time	How long it took for the in-phase monitor to achieve synchronized transfer (s).

Event Log

View Log	250 time stamped events, latest first.
Clear Log	Delete all log entries.

Harmonics

Harmonic components up to 15th are calculated for the selected phase.

Measured Phase	Disabled*	
	Phase 1	
	Phase 2	
	Phase 3	
Voltage	Total distortion	THD for each phase of both voltage sources.
	S1 Components	Each harmonic component of the selected S1 phase.
	S2 Components	Each harmonic component of the selected S2 phase.

Power Factor

Enabled only when current measurement module is connected.

Settings ***Default**



Standard I/O settings

I 01 / I 02 / I 03

Function	No function	Input disabled.
Emergency Stop* (default in I 01)		Transfers to O position in delayed transition I-O-II type switches. Disables automatic control mode in both delayed and open transition types.
Remote Test On Load* (default in I 02)		Start/stop test on load sequence in rising (NO) or falling (NC) edge of the input signal.
Remote Test Off Load* (default in I 03)		Start/stop test off load sequence in rising (NO) or falling (NC) edge of the input signal.
Inhibit ATS		Prevent switch control operations, configuration, test sequences and generator start in case of priority source failure.
Manual Retransfer		Disables automatic retransfer back to priority source.
Source Priority S1		Sets priority for source 1 in transformer-transformer application.
Source Priority S2		Sets priority for source 2 in transformer-transformer application.
Inhibit Transfer		Disables automatic transfer from priority to non-priority source.
Bypass Running Time Delays		Bypass any currently running time delay.
Remote Control to S1		Transfer to S1 when active. Overridden by activated 'Remote Control to OFF' signal.
Remote Control to OFF		Transfer to O position when active.
Remote Control to S2		Transfer to S2 when active. Overridden by activated 'Remote Control to OFF' or 'Remote Control to S1' signals.
Reset Alarm		Reset any active switch control alarms (open I failure, close I failure, open II failure, close II failure).
Manual-Auto Mode		Toggle automatic/HMI control mode, input is active only in rising/falling edge according to contact type.
Contact Type	NC	Active open
	NO*	Active closed

Continued on the next page

Settings (continued)

*Default



Standard I/O settings (continued)

O 01

Function	No function	Output disabled.
Alarm / Product availability*		Signals any active alarms or ATS being disabled for automatic transfer operations.
Load Connected to S1		Switch in position I.
Load Disconnected		Switch in position O.
Load Connected to S2		Switch in position II.
Pre-transfer Signal 1		Signal is activated and transfer is delayed according to pre-transfer delay. Signal is kept activated according to post-transfer delay after transfer.
Pre-transfer Signal 2		Signal is activated and transfer is delayed according to pre-transfer delay. Signal is kept activated according to post-transfer delay after transfer.
Pre-transfer Signal 3		Signal is activated and transfer is delayed according to pre-transfer delay. Signal is kept activated according to post-transfer delay after transfer.
Pre-transfer Signal 4		Signal is activated and transfer is delayed according to pre-transfer delay. Signal is kept activated according to post-transfer delay after transfer.
Source 1 available		No anomalies in S1 voltage supply.
Source 2 available		No anomalies in S2 voltage supply.
Load Shed 1		Used for shedding non-essential loads before transferring to non-priority source. Signal is activated before transferring to non-priority source according to load shed delay and kept activated until load is transferred back to priority source.

Continued on the next page

Settings (continued) ***Default**



Standard I/O settings (continued)

O 01 (continued)

Function (continued)

- Elevator pre-signal 1 Signal is activated and transfer is delayed according to Elevator pre-signal delay. Signal is kept activated according to Elevator post-signal delay after transfer.
- Elevator pre-signal 2 Signal is activated and transfer is delayed according to Elevator pre-signal delay. Signal is kept activated according to Elevator post-signal delay after transfer.
- Elevator pre-signal 3 Signal is activated and transfer is delayed according to Elevator pre-signal delay. Signal is kept activated according to Elevator post-signal delay after transfer.
- Elevator pre-signal 4 Signal is activated and transfer is delayed according to Elevator pre-signal delay. Signal is kept activated according to Elevator post-signal delay after transfer.

Contact Type	NC	Active open.
	NO*	Active closed.

Modules (See Chapter 5, Electronic accessories)

System

RESET to Factory Setting	Restore default parameter values
Date ¹⁾	Month day, year
Time ¹⁾	Hours:Minutes
Language	English*
	Italian
	French
	German
	Spanish
	Russian
	Chinese
New Password	Five digits
Temperature Unit	Celcius*
	Fahrenheit
Clock Format	24 h*
	12 h

¹⁾ Clock capacitor must be charged before inserting Date/Time. Clock capacitor is charged from source voltage (not AUX) and takes about 10 minutes. Clock capacitor keeps the date/time saved for 48 h in case of no source voltage available.

Settings (continued)

***Default**



Standard I/O Settings (continued)

View

Ammeter Phase

I Max*

Ne

L1

L2

L3

S1 Voltmeter Phase

V Max*

U12

U23

U31

S2 Voltmeter Phase

V Max*

U12

U23

U31



Test	*Default	
T	On-Load Test Settings	
	Bypass Local Test	
	Bypass if Generator Fails*	
	Stay on Generator	
	Bypass Remote Test	
	Bypass if Generator Fails*	
	Stay on Generator	
	Bypass Generator Exerciser	
	Bypass if Generator Fails*	
	Stay on Generator	
	Test On Load	Test generator with transferring the load. Test with switch transfer.
	Test Off Load	Test generator without transferring the load. Test without switch transfer.
HMI Test	Initiate display test screen and turn all LED's on. This function is not available when time delay is ongoing.	
Optional modules (See Chapter 5, Electronic accessories)		

About		
i	HMI	HMI serial number
		Software version
		Software subversion
		HMI Type code
	Controller Unit	Time
		Date
		Serial number
		Normative
		Controller software version
		Controller software subversion
Automatic Transfer Switch	TAG name	
	ATS Type Code	
	ATS serial number	
	Rated current	
	Number of Poles	
	ATS Type	
Modules (See Chapter 5, Electronic accessories)		

4.4 Analog meters and Measures

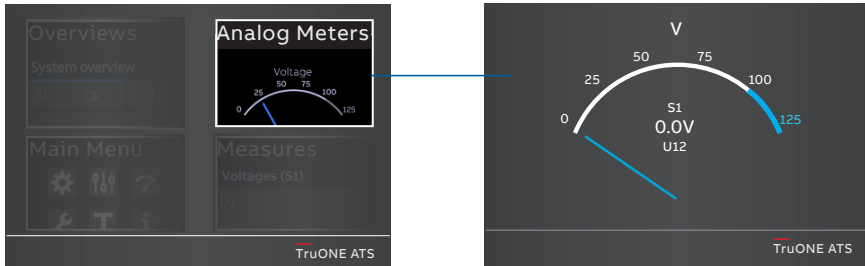

Fig. 4.3 By touching on Start Menu upper right corner -image you can find the analog meters information, see the table below

S1 Voltage meter

S2 Voltage meter

Current meter

Power meter

VAR meter

VA meter

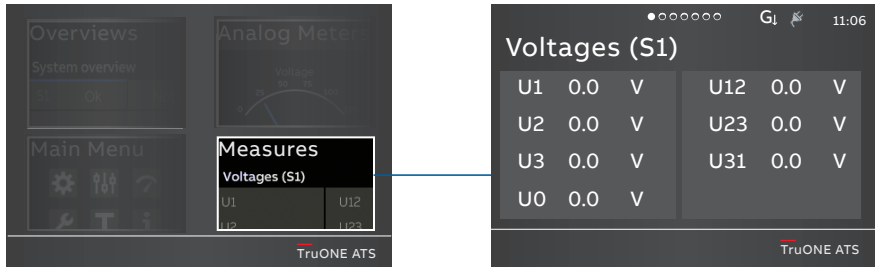

Fig. 4.4 By touching on Start Menu lower right corner -image you can find the measured data, see the table below

Voltages (S1)

Voltages (S2)

Current

Active power

Reactive power

Apparent power

Energy counters

5. Electronic accessories



Warning

Hazardous voltage may be present within the panel when connecting electronic accessories. Remove all sources of power to the ATS panel before connecting Ekip modules.

Ekip Connect Software and Bluetooth and Programming -modules are suitable for all ZTS(D) 30-1200 A, 200-480 Vac automatic transfer switches, refer to chapters 5.1-5.3. for more details on:

- Ekip Connect -software
- Ekip Bluetooth -module
- Ekip Programming -module

Ekip Signalling and Com modules are suitable for all ZTS(D) 30-1200 A, 200-480 Vac automatic transfer switches. These modules are mounted with auxiliary power supply module, OXEA1 (refer to Chapter 10.3 for further details).

Ekip-modules mounted with auxiliary power supply module are (see chapters 5.4-5.8):

- Ekip Signalling 2K_
- Ekip Com modules
- Ekip Com Modbus RTU
- Ekip Com Profibus DP
- Ekip Com DeviceNet
- Ekip Com Modbus TCP
- Ekip Com Profinet
- Ekip Com EtherNet/IP
- Ekip Link

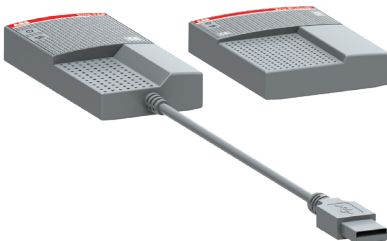

Fig. 5.1 Programming and bluetooth -modules

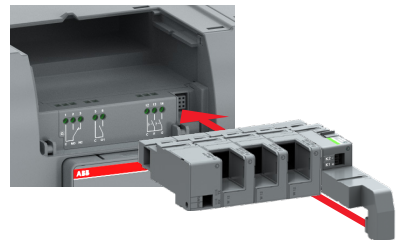

Fig. 5.2 Ekip Signalling, Com and Link -modules are mounted to automatic transfer switch OX_ with a auxiliary power supply module, OXEA1

5.1 Using Ekip Connect -software

Ekip Connect is a free software for communication and testing of ABB automatic transfer switches. The software is compatible with ZTS(D) 30-1200 A, 200-480 Vac automatic transfer switches. It can be installed on PCs equipped with the Microsoft Windows® operating system. To download it, see the address below: <http://www.abb.com/abblibrary/DownloadCenter/>

With its communication function, it allows you to:

- Monitor the state of the automatic transfer switches connected and record information.
- Configure the automatic transfer switches with customized parameters.
- Configure the electronic accessories, connected to the automatic transfer switch via Local Bus.
- Create communication reports.
- Reset configurations.

Further information on the Ekip Connect application is available from the web site, see the address below, particularly the manual 1SDH000891R0002.

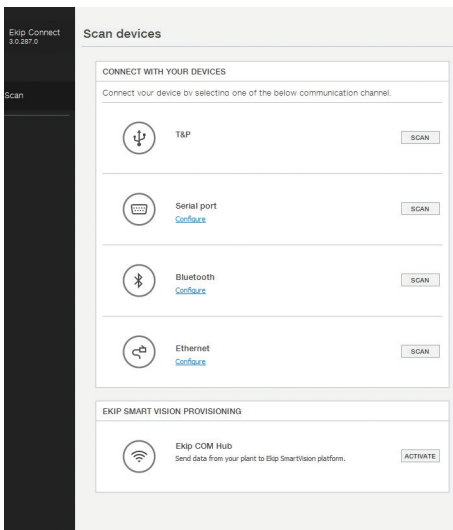

Fig. 5.3 Ekip Connect -software

5.2 Using Ekip Programming -module

The Ekip Programming -module is suitable to use with all ZTS(D) 30-1200 A, 200-480 Vac automatic transfer switches. You can connect the module via the programming port, see Fig. 5.6. The programming port is only compatible for use with Ekip Programming and Ekip Bluetooth -modules.

Ekip Programming -module allows you to:

- With Ekip Connect software update the software and load, set and read the parameters

The Ekip Programming -module draws its power from the PC and connects one side directly to the programming port (see Fig. 5.6) and on the other to the USB port of the PC with the cable supplied.



Notice

Ekip Programming only powers the controller board (HMI and external modules excluded). Therefore, in order to identify all connected parts with Ekip Connect, the auxiliary power supply module, type OXE A1, must be used (see chapter 5.4).

5.2.1 LED indications

Ekip Programming -module turns on after connecting to the PC, and is equipped with two LEDs. The first, illuminates green indicating that the module is on, and the second, illuminates yellow indicating active communication.

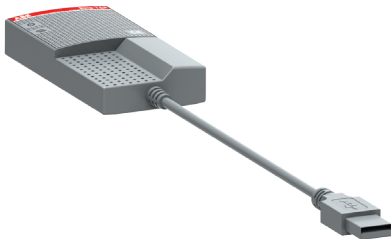

Fig. 5.4 Ekip Programming -module

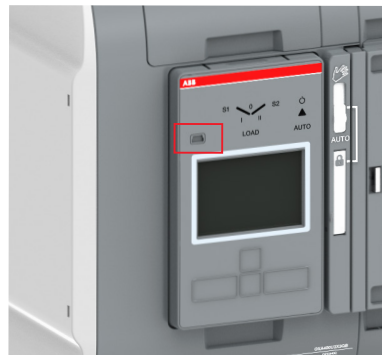

Fig. 5.5 Programming port (USB port) is situated in the front of the HMI, on left side

5.3 Auxiliary power supply module

When connected to a 12-24 Vdc source, the auxiliary power supply module, type OXEA1, supplies power to the external Ekip-modules, HMI and main control unit. It is supplied by external supply, for example from generator battery or from isolated transformer connected to the main power circuit. Powering product only with Auxiliary power supply module limits

some operation functions of the main control unit, for example: Operation of the main switch contacts is not possible.

Connections are push-in spring terminals, no tool is required.

For external wiring, cable cross section; AWG 22-16 / 0.5-1.5 mm².

5.3.1 Electrical characteristics

The following table lists the electrical characteristics of OXEA1:

Module	OXEA1	
Power supply input voltage	12 - 24 V DC ± 10 % SELV	
Nominal power consumption	5 - 12 W	
Inrush current	Maximum 2 A	

Table 5.1 Electrical characteristics of auxiliary power supply module OXEA1

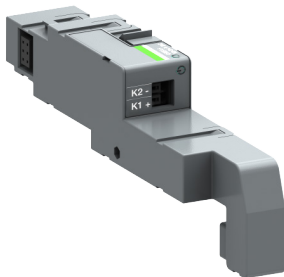

Fig. 5.6 Auxiliary power supply module, type OXEA1, is needed when Ekip Signalling, Com and Link -modules are mounted to automatic transfer switch OX_

5.3.2 LED indications

LED	Indication	Description
Power LED, green	On, fixed	Power is connected to the input of the module.
	Off	Power is not connected.

Table 5.2 Indication / auxiliary power supply module OXEA1



Fig. 5.7 Signals of auxiliary power supply module OXEA1

5.4 Using Ekip Signalling 2K-_-module

The Ekip Signalling 2K-_- is a signalling accessory module. It is suitable for all ZTS(D) 30-1200 A, 200-480 Vac automatic transfer switches. The module has:

- Two digital inputs, and two contacts for output signals.
- A power status LED, and four signalling LEDs (one LED for every input/output).



Notice

On each ATS, a maximum of three Ekip Signalling 2K modules can be installed: one 2K-1, one 2K-2, and one 2K-3. These modules differ by their name and label, and have distinct wiring, but they are identical in terms of their characteristics and manner of installation.



Fig. 5.8 Ekip Signalling 2K -module

5.4.1 Electrical characteristics of Ekip Signalling 2K-_-module

The following table lists the electrical characteristics of the module:

Component	Characteristics
Output contacts	Maximum switching voltage*: 150 V DC / 250 V AC
	Breaking power*: 2 A @ 30 V DC, 0.8 A @ 50 V DC, 0.2 A @ 150 V DC, 4 A @ 250 V AC
	Dielectric strength between each contact and coil: 1000 V AC (1 minute @ 50 Hz)
Input contacts	Dielectric strength between open contacts: 1000 V AC (1 minute @ 50 Hz)
	5 V@2.5 mA Do not connect to any power supply

*Data relating to a resistive load

Table 5.3 Electrical characteristics of Ekip Signalling 2K-_-module

5.4.2 Access from the display / Ekip Signalling 2K-_-module

With modules energized, and Local Bus enabled, the presence of the modules on the module slot activates additional menus on the display:

- In order to configure the inputs and output contacts.
- To display information on the modules and the state of inputs and outputs.

The following table illustrates the path for accessing the configuration parameters of the module from the display:

Settings (*Default)		Description
Modules (Optional modules)		
Ekip Signalling 2K-1 / -2 / -3		
I 11/12, I 21/22, I 31/32		
Function	No Function*	Input disabled
	Emergency Stop	Transfers to O position in delayed transition I-O-II type switches. Disables automatic control mode in both delayed and open transition types.
	Remote Test on Load	Start/stop test on load sequence in rising (NO) or falling (NC) edge of the input signal.
	Remote Test off Load	Start/stop test off load sequence in rising (NO) or falling (NC) edge of the input signal.
	Inhibit ATS	Prevent switch control operations, configuration, test sequences and generator start in case of priority source failure.
	Manual Retransfer	Disables automatic transfer back to priority source.
	Source Priority S1	Sets priority for source 1 in transformer-transformer application.
	Source Priority S2	Sets priority for source 2 in transformer-transformer application.
	Inhibit Transfer	Disables automatic transfer from priority source to non-priority source.
	Bypass Running Time Delays	Bypass any currently running time delay.
	Remote Control to S1	Transfer to S1 when active. Overridden by activated 'Remote Control to OFF' signal.
	Remote Control to OFF	Transfer to position O when active.
	Remote Control to S2	Transfer to S2 when active. Overridden by activated 'Remote Control to OFF' or 'Remote Control to S1' signals.
	Reset Alarm	Reset any active switch control alarms (open I failure, close I failure, open II failure, close II failure).
	Manual-Auto Mode	Toggle automatic/HMI control mode, input is active only in rising/falling edge according to contact type.
Contact Type	NC	Active open
	NO*	Active closed

Continued on the next page

Settings (*Default)		Description
Modules (Optional modules) (continued)		
O 11/12, O 21/22, O 31/32		
Function*	Function No	Output disabled
	Alarm/Product Availabilit	Signals any active alarms or ATS being disabled for automatic transfer operations.
	Load Connected to S1	Switch in position I.
	Load Disconnected	Switch in position O.
	Load Connected to S2	Switch in position II
	Pre-transfer Signal 1	Signal is activated and transfer is delayed according to pre-transfer delay. Signal is kept activated according to post-transfer delay after transfer.
	Pre-transfer Signal 2	Signal is activated and transfer is delayed according to pre-transfer delay. Signal is kept activated according to post-transfer delay after transfer.
	Pre-transfer Signal 3	Signal is activated and transfer is delayed according to pre-transfer delay. Signal is kept activated according to post-transfer delay after transfer.
	Pre-transfer Signal 4	Signal is activated and transfer is delayed according to pre-transfer delay. Signal is kept activated according to post-transfer delay after transfer.
	Source 1 Available	No anomalies in S1 voltage supply.
	Source 2 Available	No anomalies in S2 voltage supply.
	Load Shed 1	Used for shedding non-essential loads before transferring to non-priority source. Signal is activated before transferring to non-priority source according to load shed delay and kept activated until load is transferred back to priority source.
	Elevator pre-signal 1	Signal is activated and transfer is delayed according to Elevator pre-signal delay. Signal is kept activated according to Elevator post-signal delay after transfer.
	Elevator pre-signal 2	Signal is activated and transfer is delayed according to Elevator pre-signal delay. Signal is kept activated according to Elevator post-signal delay after transfer.
	Elevator pre-signal 3	Signal is activated and transfer is delayed according to Elevator pre-signal delay. Signal is kept activated according to Elevator post-signal delay after transfer.
	Elevator pre-signal 4	Signal is activated and transfer is delayed according to Elevator pre-signal delay. Signal is kept activated according to Elevator post-signal delay after transfer.
Contact Type	NC	Active open
	NO*	Active closed

Test	
:	
Modules (Optional modules)	
Ekip Signalling 2K-1 / -2 / -3	Auto Test
:	

Table 5.5 Configuration and test parameters of Ekip Signalling 2K_-module in HMI

The following table illustrates the path from the display for accessing information on the module:

About	Description
:	
Modules (Optional modules)	
Ekip Signalling 2K-1 / -2 / -3	
SN	Serial number
Version	Software version
Input 1	The logical state of the inputs: "Off" if not active, "On" if active
Input 2	
Output 1	The state of the output contacts: "Open" if open, "Closed" if closed
Output 2	
:	

Table 5.4 Information of Ekip Signalling 2K_-module in HMI

5.4.3 LED indications and inputs/outputs of Ekip Signalling 2K_-module

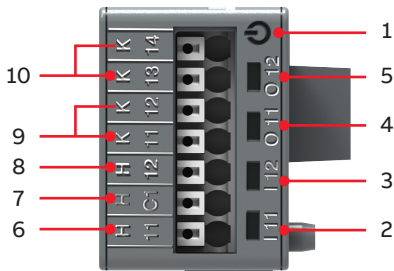

Fig. 5.9 Signals and inputs/outputs of Ekip Signalling 2K_-module

- 1 Power LED, green. The possible states are:
 - Off: power supply absent.
 - On fixed: power supply and communication with the device present.
 - On, with two quick flashes per second (not synchronized with those of the green LED on the device): power supply present, and communication with device absent (for example: for Local Bus disabled)¹⁾
- 2 Green³⁾ LED for signalling the physical state of the input H x 1²⁾. The possible states are:
 - Off: floating input
 - On fixed: input short-circuited on H Cx²⁾
- 3 Green³⁾ LED for signalling the physical state of the input H x2²⁾. The possible

states are:

- Off: floating input
 - On fixed: input short-circuited on H Cx
- 4 Green³⁾ LED for signalling contact K x1 - K x2²⁾. The possible states are:
 - Off: contact open
 - On fixed: contact closed
 - 5 Green³⁾ LED for signalling the state of the contact K x3 - K x4²⁾. The possible states are:
 - Off: contact open
 - On fixed: contact closed
 - 6 Input I x1
 - 7 Conductive part of the inputs H x1 and H x2²⁾
 - 8 Input I x2²⁾
 - 9 Output contact pin O x1²⁾
 - 10 Output contact pin O x2²⁾

- 1) The absence of communication is signalled immediately by the power LED, unlike the outputs which (apart from those programmed to be activated in the case of disconnection) are deactivated if the condition persists for at least 8 s
- 2) With x = 1, 2, or 3
- 3) The LED turns on and off according to the physical state of the input, without taking any account of how the Delay parameter is set.

For external wiring, cable cross section;
AWG 22-16 / 0.5-1.5 mm².

5.5 Using Ekip Com _ -modules

Suitable Ekip Com _ -modules are:

- Ekip Com Modbus RTU
- Ekip Com Profibus DP
- Ekip Com DeviceNet
- Ekip Com Modbus TCP
- Ekip Com Profinet
- Ekip Com EtherNet/IP

5.5.1 Ekip Com Modbus RTU -module

The Ekip Com Modbus RTU is a communication accessory module, that integrates the automatic transfer switch in an industrial remote supervision and control network. The module is suitable for all ZTS(D) 30-1200 A, 200-480 Vac automatic transfer switches.

It can be connected to a RS-485 network with a Modbus RTU communication protocol, and allows you to:

- Connect the automatic transfer switch to the network, with dialog functionality.
- Provide the status information of the automatic transfer switch (e.g. open, closed).

For the communication lines W1 (A) and W2 (B), Belden type 3105 A or equivalent cables must be used.



Fig. 5.10 Ekip Com Modbus RTU -module

5.5.1.1 LED indications

The following table illustrates the possible signals, and their meaning:

LED	Indication	Description
Power LED, green	Off	Power supply absent.
	On fixed	Power supply and communication with the device present.
	On, with two quick flashes per second	Power supply present, and communication with device absent.
RX and TX LEDs, green	Off	Modbus RTU communication not active.
	On, flashing rapidly	Modbus RTU communication active.

Table 5.6 Indication / Ekip Com Modbus RTU -module

5.5.1.2 Termination resistor

On the Ekip Com Modbus RTU module it is possible to activate the terminating resistance $R_{term} = 120 \Omega$. To enable the R_{term} , the corresponding dip-switches 1 and 2 (on the side of the module) must be positioned to ON. This option must be selected before the installation of the module.

With the Ekip Com Modbus RTU modules, the dip-switches 3 and 4 of the R_{pol} (polarization resistance), are not used.



Fig. 5.11 Signals of Ekip Com Modbus RTU -module

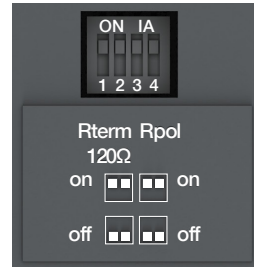

Fig. 5.12 Termination resistor; To enable the R_{term} , the dip-switches 1 and 2 must be positioned to ON. This option must be selected before the installation of the module

5.5.1.3 Access from the display / Ekip Com Modbus RTU –module

With modules connected and energized the presence of the modules on the module slot activates additional menus on the display. The following table illustrates the path for accessing the configuration parameters of the modules from the display:

Settings (*Default value)		Description
:		
Modules (Optional modules)		
Ekip Com Modbus RTU		
Serial address	1-247, default 247*	Address to be assigned to the modules. NOTE: devices connected to the same network must have different addresses
Baudrate	9600 bit/s, 19200 bit/s*, 38400 bit/s	Data transmission speed
Physical protocol	8.E,1*, 8.O,1, 8.N,2, 8.N,1	8.E,1 = 8 data bits, 1 EVEN parity bit, 1 STOP bit 8.O,1 = 8 data bits, 1 ODD parity bit, 1 STOP bit 8.N,2 = 8 data bits, no parity bit, 2 STOP bits 8.N,1 = 8 data bits, no parity bit, 1 STOP bit
:		

Table 5.7 The path for accessing the configuration parameters of the Ekip Com Modbus RTU -module from the display

The following table illustrates the path from the display for accessing information on the module:

About	Description
:	
Modules (Optional modules)	
Ekip Com Modbus RTU	
SN	Serial number
Version	Software version
:	

Table 5.8 Information of Ekip Com Modbus RTU -module in HMI

5.5.2 Ekip Com Profibus DP -module

The Ekip Com Profibus DB is a communication accessory module, that integrates the automatic transfer switch in an industrial remote supervision and control network. The module is suitable for all ZTS(D) 30-1200 A, 200-480 Vac automatic transfer switches.

It can be connected to a network RS-485 of Profibus communication protocol, and allows:

- Connecting the automatic transfer switch as a slave to the network, with dialog functionality.
- Provide the status information of the automatic transfer switch (e.g. open, closed).

For the communication lines W5 (B) and W6 (A), Belden type 3079A or equivalent cables must be used.

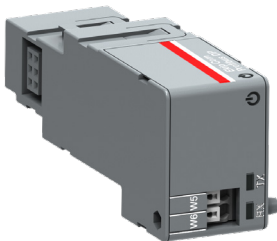

Fig. 5.13 Ekip Com Profibus DP -module

5.5.2.1 LED indications

The following table illustrates the possible signals, and their meaning:

LED	Indication	Description
Power LED, green	Off	Power supply absent.
	On fixed	Power supply and communication with the device present.
	On, with one flash per second	Power supply and communication with device present.
RX LED, green	On, with two quick flashes per second	Power supply present, and communication with device absent.
	Off	Communication not active.
TX LED, green	On, fixed	Communication active.
	Off	Communication not active.
TX LED, green	On, flashing	Communication active.

Table 5.9 Indication / Ekip Com Profibus DP -module

5.5.2.2 Termination resistor

The Ekip Com Profibus DP modules provide the possibility to insert a 220 Ω termination resistor on the RS-485 bus, by setting the DIP-switches Rterm (1 and 2) on the side of the modules, in position ON.

In the event of termination of the bus, a 390 Ω pull-up or pull-down resistor must also be inserted on the lines, by setting the DIP-switches Rpol (3 and 4), in position ON.

These options must be selected before installation of the modules.

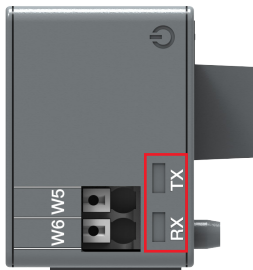

Fig. 5.14 Signals of Ekip Com Profibus DB -module

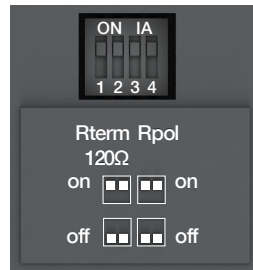

Fig. 5.15 Termination resistor; To enable the Rterm, the dip-switches 1 and 2 must be positioned to ON. When Rterm is activated, the Rpol must also be activated by turning dip-switches 3 and 4 to ON-position. These options must be selected before the installation of the modules

5.5.2.3 Access from the display / Ekip Com Profibus DB -module

With modules connected and energized, the presence of the modules on the module slot activates additional menus on the display.

The following table illustrates the path for accessing the configuration parameters of the modules from the display:

Settings (*Default value)	Description
:	
Modules (Optional modules)	
Ekip Com Profibus DB	
Serial address	1-125, default 125*
	Address to be assigned to the modules. IMPORTANT: devices connected to the same network must have different addresses
:	

Table 5.10 Configuration of Ekip Com Profibus DB -module in HMI

The following table illustrates the path from the display for accessing information on the module:

About	Description
:	
Modules (Optional modules)	
Ekip Com Profibus DB -module	
SN	Serial number
Version	Software version
:	

Table 5.11 Information of Ekip Com Profibus DB -module in HMI

5.5.3 Ekip Com DeviceNet -module

The Ekip Com DeviceNet –module is a communication accessory module, that integrates the automatic transfer switch in an industrial remote supervision and control network. The module is suitable for all ZTS(D) 30-1200 A, 200-480 Vac automatic transfer switches.

It can be connected to a CAN network with a DeviceNet™ communication protocol, and allows you to:

- Connect the automatic transfer switch as a slave to the network, with dialog functionality.
- Provide the status information of the automatic transfer switch (e.g. open, closed).

For the communication lines, Belden type 3084A or equivalent cables must be used.

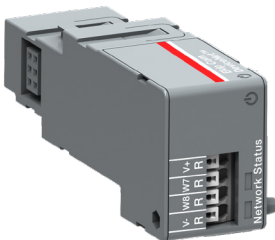

Fig. 5.16 Ekip Com DeviceNet -module

5.5.3.1 LED indications

The following table illustrates the possible signals, and their meaning:

LED	Indication	Description
Power LED, green	Off	Power supply absent.
	On fixed	Power supply and communication with the device present.
	On, with two quick flashes per second	Power supply present, and communication with device absent.
Network LED, red	Off	Device off line (with red LED off) ¹⁾ , or in error conditions (with red LED on).
	On, fixed	Device on line, and allocated on a master (operating condition).
	On, flashing	Device on line, but not allocated on a master (device ready for communication).
Status LED, green	Off	No error.
	On, fixed	Device in bus off, or Network Power absent condition.
	On, flashing	I/O connection (cyclic data) in timeout.

¹⁾ The device has not yet sent Duplicate ID sequence on line.

Table 5.12 Indication / Ekip Com DeviceNet -module in HMI



Fig. 5.17 Signals of Ekip Com DeviceNet -module

5.5.3.2 Termination resistor

The modules provide the possibility to insert a 120 Ω termination resistor on the CAN bus, by setting the DIP-switches Rterm (1 and 2) on the side of the modules, in position ON. This option must be selected before the installation of the modules. With the Ekip Com DeviceNet - modules, the dip-switches 3 and 4 of the Rpol (polarization resistance), are not used.



Notice

The termination resistors must never be included in the nodes. The inclusion of this capability could easily lead to a network with improper termination (impedance too high or too low), potentially causing a failure. For example the removal of a node, which includes a termination resistor, could result in a network failure. The termination resistors must not be installed at the end of a branch (drop line), only at the two ends of the main backbone (trunk line).

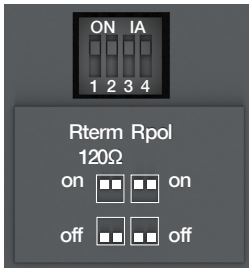

Fig. 5.18 Termination resistor; To enable the Rterm, the dip-switches 1 and 2 must be positioned to ON. This option must be selected before the installation of the module.

5.5.3.3 Access from the display / Ekip Com DeviceNet –module

With modules connected and energized, the presence of the modules on the module slot activates additional menus on the display.

The following table illustrates the path for accessing the configuration parameters of the modules from the display:

Settings (*Default value)	Description
:	
Modules (Optional modules)	
Ekip Com DeviceNet	
MAC address 1-63, default 63*	Address to be assigned to the modules. IMPORTANT: devices connected to the same network must have different addresses
Baudrate 125 kbit/s, 250 kbit/s*, 500 kbit/s	Data transmission speed
:	

Table 5.13 The path for accessing the configuration parameters of the Ekip Com DeviceNet -module from the display

The following table illustrates the path from the display for accessing information on the module:

About	Description
:	
Modules (Optional modules)	
Ekip Com DeviceNet	
SN	Serial number
Version	Software version
:	

Table 5.14 Information of Ekip Com DeviceNet -module in HMI

5.5.4 Ekip Com Modbus TCP -module

Ekip Com Modbus TCP is an accessory module that can function as a communication module integrating the automatic transfer switch in an industrial remote supervision and control network or as an HTTP Server. The module is suitable for all ZTS(D) 30-1200 A, 200-480 Vac automatic transfer switches.

As a communication module, it can be connected to an Ethernet network with the Modbus TCP communication, and allows:

- Connecting the automatic transfer switch to the network, with dialog functionality.
- Provide the status information of the automatic transfer switch (e.g. open, closed).

As an HTTP Server, connected to an Ethernet network it allows read-only access to the information of the automatic transfer switch. This access is possible through a browser, inserting the IP address of the module as the URL. Once the switch has been found, a login page is opened that asks for the user password to be inserted, which is the same password to be inserted in the display in order to edit parameters.



Notice

Since the module allows access to the data contained in the automatic transfer switch, it can only be connected to networks that meet all the necessary requirements for safety and prevention of unauthorized access (for example, the network of the control system of an installation). It is the installer's responsibility to ensure that all the necessary safety measures are adopted (for example, firewalls, and so on). The module cannot be connected directly to the Internet. It is recommended to connect it only to dedicated Ethernet networks, with the Modbus TCP communication protocol.

For the communication bus, a cable of type Cat.6 S/FTP must be used (Cat.6 with S/FTP double shielding).

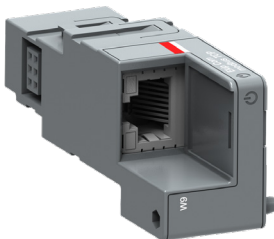

Fig. 5.19 Ekip Com Modbus TCP -module

The following table illustrates the ports used by the module:

Port	Service	Notes
502/tcp	Modbus TCP	When the module is used as a Modbus TCP/IP communication module.
80/tcp	Server HTTP	When the module is used as a Server HTTP.
319/udp	IEEE 1588	When IEEE protocol 1588 is enabled
320/udp		

Table 5.15 Ports of Ekip Com Modbus TCP -module

5.5.4.1 LED indications

The following table illustrates the possible signals, and their meaning:

LED	Indication	Description
Power LED, green	Off	Power supply absent.
	On fixed	Power supply and communication with the device present.
	On, with two quick flashes per second	Power supply present, and communication with device absent.
Link LED, green	Off	Connection error (signal absent).
	On, fixed	Correct connection.
Activity LED, yellow	Off	No activity on the line.
	On, flashing	Activity present on the line (in reception and/or transmission).

Table 5.16 Indication / Ekip Com Modbus TCP -module

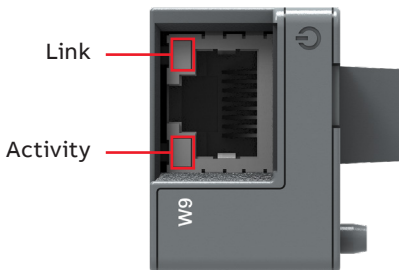

Fig. 5.20 Signals of Ekip Com Modbus TCP -module

5.5.4.2 Access from the display / Ekip Com Modbus TCP –module

With modules connected and energized, the presence of the modules on the module slot activates additional menus on the display:

- For setting the function and addressing of the modules.
- In order to display information on the modules.

The following table illustrates the path from the display, for setting the function and addressing of the modules:

Settings (* Default value)		Description
:		
Modules (Optional modules)		
Ekip Com Modbus TCP		
Function	HTTP Server	HTTP Server operating mode.
	TCPCModbus*	Communication module operating mode.
Force Static IP address	Off*	Dynamic IP address.
	On	Static IP address.
Static IP Address		Displayed with static IP Address enabled, it must be selected in order to insert the IP Address of the modules.
Static Network Mask		Displayed with static IP Address enabled, it must be selected in order to insert the subnet mask of the modules.
Static Gateway addr		Displayed with static IP Address enabled, it must be selected in the presence of multiple subnets, in order to insert the IP Address of the node to which the modules are connected.
:		

Table 5.17 The path for setting the function and addressing of the modules of the Ekip Com Modbus TCP -module from the display

The following table illustrates the path from the display for accessing information on the module:

About	Description
:	
Modules (Optional modules)	
Ekip Com Modbus TCP	
SN	Serial number
Version	Software version
IP Address	This is the address assigned to the modules at the moment of connection to the network. It consists of four bytes (for a total of 32 bits), each of which can have value from 0 to 255. By default, allocation is dynamic. With dynamic allocation, the modules wait to receive the IP address from a DHCP server. Without a DHCP server, the modules adopt an Autoconfiguration IP Address in the range 169.254.xxx.xxx, calculated in a pseudo random manner so as to be the same at every switch-on. Alternatively, you can enable the static IP address option, which allows the IP address to be forced. In this case, you must make sure that the IP Address inserted is different to that of the other devices connected to the same network.
Network Mask	This is the subnet mask, and identifies the method to recognize the subnet to which the modules belong, with the possibility of searching for the modules within a defined set of recipients. If you enabled the option Static IP Address, you must also enter the correct Network Mask.
Gateway Address	The IP address of the node to which the module it is connected, in the presence of multiple subnets. If you enabled the Static IP Address option, you must also enter the correct Gateway Address.
TCP Client	There are three IP Addresses of the client devices connected to the modules.
MAC Address	It is the address assigned by ABB, having a OUI equal to ac:d3:64 ¹⁾ .
:	

¹⁾ Organizationally Unique Identifier, formed from the first three bytes of a MAC address, and which uniquely identifies the manufacturer of an Ethernet device.

Table 5.18 Information of Ekip Com Modbus TCP -module in HMI

5.5.5 Ekip Com Profinet -module

The Ekip Com Profinet is a communication accessory module, that integrates the automatic transfer switch in an industrial remote supervision and control network. The module is suitable for all ZTS(D) 30-1200 A, 200-480 Vac automatic transfer switches.

It can be connected to an Ethernet network with a Profinet communication protocol, and allows you to:

- Connect the automatic transfer switch to the network, with dialog functionality.
- Provide the status information of the automatic transfer switch (e.g. open, closed).



Notice

The module can only be connected to networks that meet all the necessary requirements for safety and prevention of unauthorized access (for example, the network of the control system of an installation). It is the installer's responsibility to ensure that all the necessary safety measures are adopted (for example, firewalls, and so on). It is recommended to connect it only to dedicated Ethernet networks, with the Profinet communication protocol. The module cannot be connected to the Internet.

For the communication bus, a cable of type Cat.6 S/FTP must be used (Cat. 6 with S/FTP double shielding).



Fig. 5.21 Ekip Com Profinet -module

The following table illustrates the ports used by the module:

Ethertype	Port	Service	Notes
0x88CC	-	LLDP	Link Layer Discovery Protocol
0x8892 (Profinet)	-	Profinet IO	Specific for real time communications (RT)
0x0800	34964/udp	Profinet-cm (Context Manager)	DCE/RP

Table 5.19 Ports of Ekip Com Profinet -module

5.5.5.1 LED indications

The following table illustrates the possible signals, and their meaning:

LED	Indication	Description
Power LED, green	Off	Power supply absent.
	On fixed	Power supply and communication with the device present.
	On, with two quick flashes per second	Power supply present, and communication with device absent.
Link LED, green	Off	Connection error (signal absent).
	On, fixed	Correct connection.
Activity LED, yellow	Off	No activity on the line.
	On, flashing	Activity present on the line (in reception and/or transmission).

Table 5.20 Indication / Ekip Com Profinet -module

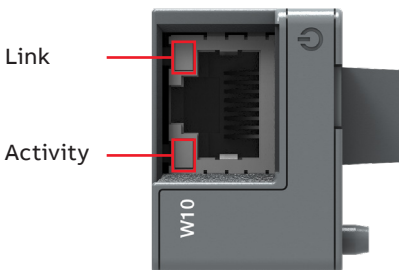

Fig. 5.22 Signals of Ekip Com Profinet -module

**5.5.5.2 Access from the display
/ Ekip Com Profinet -module**

The following table illustrates the path from the display for accessing information on the module:

About	
:	
Modules (Optional modules)	
Ekip Com Profinet -module	
SN	Serial number
Version	Software version
MAC Address	It is the address assigned by ABB and with an OUI (Organizationally Unique Identifier, formed of the first three bytes of a MAC address, and which uniquely identifies the manufacturer of an Ethernet device) equal to ac:d3:64.
:	

Table 5.21 Information of Ekip Com Profinet -module

5.5.6 Ekip Com EtherNet/IP -module

The Ekip Com EtherNet/IP is an accessory module that can act as a communication module integrating the automatic transfer switch in an industrial remote supervision and control network. The module is suitable for all ZTS(D) 30-1200 A, 200-480 Vac automatic transfer switches.

It can be connected to an Ethernet network with a EtherNet/IP™ -communication protocol, and allows you to:

- Connect the automatic transfer switch to the network, with dialog functionality.
- Provide the status information of the automatic transfer switch (e.g. open, closed).



Notice

Since this module allows the access to the data contained in the automatic transfer switch, it can only be connected to networks possessing all the necessary requirements for security and prevention of unauthorized access (for example, the network of the control system of an installation). It is responsibility of the installer to make sure that all the necessary security measures are adopted (for example firewalls and so on). The module cannot be connected directly to the Internet. It is recommended to connect it only to dedicated Ethernet networks using the EtherNet/IP™ -communication protocol.

For the communication bus, a cable of type Cat.6 S/FTP must be used (Cat.6 with S/FTP double shielding).

The following table illustrates the ports used by the module:

Port	Protocol	Notes
44818	TCP	Encapsulation Protocol (example: ListIdentity, UCMM, CIP Transport Class 3)
44818	UDP	Encapsulation Protocol (example: ListIdentity)
2222	UDP	CIP Transport Class 0 or 1

Table 5.22 Ports of Ekip Com EtherNet/IP -module



Fig. 5.23 Ekip Com EtherNet/IP -module

5.5.6.1 LED indications

The following table illustrates the possible signals, and their meaning:

LED	Indication	Description
Power LED, green	Off	Power supply absent.
	On fixed	Power supply and communication with the device present.
	On, with two quick flashes per second	Power supply present, and communication with device absent.
Link LED, green	Off	Connection error (signal absent).
	On, fixed	Correct connection.
Activity LED, yellow	Off	No activity on the line.
	On, flashing	Activity present on the line (in reception and/or transmission).

Table 5.23 Indication / Ekip Com EtherNet/IP -module

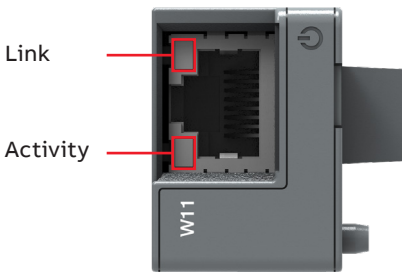

Fig. 5.24 Signals of Ekip Com EtherNet/IP -module

5.5.6.2 Access from the display / Ekip Com EtherNet/IP

With modules connected and energized, the presence of the modules on the module slot activates additional menus on the display:

- To set the addressing of the modules.
- In order to display information on the modules.

The following table illustrates the path from the display, for setting the function and addressing of the modules:

Settings (*Default value)	Description
:	
Modules (Optional modules)	
Ekip Com EtherNet/IP	
Force Static IP address	Off* On Dynamic IP address. Static IP address.
Static IP Address	Displayed with static IP Address enabled, it must be selected in order to insert the IP Address of the modules.
Static Network Mask	Displayed with static IP Address enabled, it must be selected in order to insert the subnet mask of the modules.
Static Gateway addr	Displayed with static IP Address enabled, it must be selected in the presence of multiple subnets, in order to insert the IP Address of the node to which the modules are connected.
:	

Table 5.24 The path for setting the function and addressing of the modules of the Ekip Com Ethernet/IP -module from the display

The following table illustrates the path from the display for accessing information on the module:

About	Description
:	
Modules (Optional modules)	
Ekip Com EtherNet/IP	
SN	Serial number
Version	Software version
IP Address	This is the address assigned to the modules at the moment of connection to the network. It consists of four bytes (for a total of 32 bits), each of which can have value from 0 to 255. By default, allocation is dynamic. With dynamic allocation, the modules wait to receive the IP address from a DHCP server. Without a DHCP server, the modules adopt an Autoconfiguration IP Address in the range 169.254.xxx.xxx, calculated in a pseudo random manner so as to be the same at every switch-on. Alternatively, you can enable the static IP address option, which allows the IP address to be forced. In this case, you must make sure that the IP Address inserted is different to that of the other devices connected to the same network.
Network Mask	This is the subnet mask, and identifies the method to recognize the subnet to which the modules belong, with the possibility of searching for the modules within a defined set of recipients. If you enabled the option Static IP Address, you must also enter the correct Network Mask.
Gateway Address	The IP address of the node to which the module it is connected, in the presence of multiple subnets. If you enabled the Static IP Address option, you must also enter the correct Gateway Address.
TCP Client	There are three IP Addresses of the client devices connected to the modules.
MAC Address	It is the address assigned by ABB, having a OUI equal to ac:d3:64 ¹⁾ .
:	

¹⁾ Organizationally Unique Identifier, formed from the first three bytes of a MAC address, and which uniquely identifies the manufacturer of an Ethernet device.

Table 5.25 Information of Ekip Com EtherNet/IP -module in HMI

6. Troubleshooting



Warning

Any troubleshooting should be conducted by trained and authorized personnel only. Appropriate personal protective equipment (PPE) shall be used when troubleshooting the ATS panel. Hazardous voltage may be present. Disconnect all power sources before performing work inside the ATS panel. Failure to do so may result in serious injury or death.

6.1 Alarms



LCD



Touch

Message	Fault	Action
Locked, Alarm LED on	Lock input activated	Unlock
Switch not in AUTO mode, Alarm LED on	Slide switch is in handle or lock position	Turn slide switch into the AUTO position
Phases crossed	Phase rotation of sources 1 and 2 are different	Connect the phases of both sources in the same order
S1 undervoltage	Voltage of source 1 is under the threshold level set in parameter "Drop-out voltage, lower threshold"	Check the correlation between power source and device configuration
S1 overvoltage	Voltage of source 1 is over the threshold level set in parameter "Drop-out voltage, upper threshold"	Check the correlation between power source and device configuration
S1 phase missing	One or two phases of source 1 are missing	Check the power source and connections
S1 unbalance	Phases of source 1 are not symmetric	Check the power source
S1 phase rotation	Phase rotation of source 1 is different from the value of parameter "Phase sequence"	Connect the phases according to the configuration
S1 invalid frequency	Frequency of source 1 is out of range set in parameters "Drop-out frequency, upper threshold" and "Drop-out frequency, lower threshold"	Check the correlation between power source and device configuration
S2 undervoltage	Voltage of source 2 is under the threshold level set in parameter "Drop-out voltage, lower threshold"	Check the correlation between power source and device configuration
S2 overvoltage	Voltage of source 2 is over the threshold level set in parameter "Drop-out voltage, upper threshold"	Check the correlation between power source and device configuration
S2 phase missing	One or two phases of source 2 are missing	Check the power source and connections

Table 6.1 Alarms-list in level 3 and 4, LCD and touch control interfaces

Message	Fault	Action
S2 unbalance	Phases of source 2 are not symmetric	Check the power source
S2 phase rotation	Phase rotation of source 2 is different from the value of parameter "Phase sequence"	Connect the phases according to the configuration
S2 invalid frequency	Frequency of source 2 is out of range set in parameters "Drop-out frequency, upper threshold" and "Drop-out frequency, lower threshold"	Check the correlation between power source and device configuration
Frequency Difference	Frequency difference of voltage sources is greater than 3 Hz while in-phase monitor is on	Alarm is active and transfer operations disabled as long as the frequency difference is above the accepted level
High current alarm	Measured current is higher than ten times the nominal value	Alarm is active and transfer operations disabled as long as the high current status remains
Open I failure, Alarm LED blinking	Switch transfer from position I to O or II failed	Reset alarm by pressing Auto button or via menu page Operation / Alarm Reset
Close I failure, Alarm LED blinking	Switch transfer to position I failed	Reset alarm by pressing Auto button or via menu page Operation / Alarm Reset
Open II failure, Alarm LED blinking	Switch transfer from position II to O or I failed	Reset alarm by pressing Auto button or via menu page Operation / Alarm Reset
Close II failure, Alarm LED blinking	Switch transfer to position II failed	Reset alarm by pressing Auto button or via menu page Operation / Alarm Reset
Switch position alarm, Alarm LED on	More than one switch position indication inputs are activated	Switch service needed
Pole temperature alarm	Measured pole temperature is too high	Switch service needed
Contact wear alarm	Switch contact wear is near the limit that requires maintenance	Switch service needed
Ekip Com Hub Alarm	Ekip Com Hub failure	Check configuration
HMI Not Compatible	Firmware versions of HMI and device are not compatible to be used together	Check current versions and update compatible versions

Table 6.1 Alarms-list in level 3 and 4, LCD and touch control interfaces

Message	Fault	Action
Local bus	Communication between HMI and switch controller is off	Check connection
Ethernet disconnected	Ethernet module not connected	Check connection
Fire Fighting	Fire fighting input activated	Alarm is active and disables transfer operations as long as the input is active
Control Voltage Failure	Control voltage dropped during switch control	Check power source
Control Voltage Low	Switch control voltage is below the minimum	Check power source
Configuration Error	Invalid configuration	Check parameter values
IEC 61850 Error	IEC 61850 failure	Check configuration file
Ekip Com Hub Alarm	Ekip Com Hub failure	Check configuration
HMI Not Compatible	Firmware versions of HMI and device are not compatible to be used together	Check current versions and update compatible versions

Table 6.1 Alarms-list in level 3 and 4, LCD and touch control interfaces

6.2 Warnings



LCD



Touch

Message	Reason
S1 and S2 not in sync	Voltage sources are not synchronized
Voltage Not Calibrated	Calibration data in power module is invalid or unavailable
Current Not Calibrated	Calibration data in current measurement module is invalid or unavailable
Pole temperature warning	Measured pole temperature is near the alarm level
Control Retry	Failed transfer sequence retry activated
Auto Control Disabled	Device is in manual operating mode
Local Bus	Module heartbeat error. Check connection. Can be cleared using "Alarm Reset".
Configuration	Configuration session ports are open
Clock capacitor charging	Real time clock is not yet operational, date & time setting is disabled as long as this warning is active. Clock capacitor is charged from source voltage (not AUX) and takes about 10 minutes

Table 6.2 Warnings-list in level 3 and 4, LCD and touch control interfaces

6.3 Information



Message	Description
Invalid Date	Date not set
Test on Load	Test on load sequence active
Test off Load	Test off load sequence active
Alarm/Product Availability	Digital output function activated
In Position I	Digital output function activated
In Position O	Digital output function activated
In Position II	Digital output function activated
Pre-transfer Signal 1	Digital output function activated
Pre-transfer Signal 2	Digital output function activated
Pre-transfer Signal 3	Digital output function activated
Pre-transfer Signal 4	Digital output function activated
Source 1 Available	Digital output function activated
Source 2 Available	Digital output function activated
Load Shed	Digital output function activated
Emergency Stop	Digital input function activated
Remote Test on Load	Digital input function activated
Remote Test off Load	Digital input function activated
Inhibit ATS	Digital input function activated
Manual Retransfer	Digital input function activated
Priority S1	Digital input function activated
Priority S2	Digital input function activated
Inhibit Transfer	Digital input function activated
Bypass Running Delays	Digital input function activated
Remote Control to S1	Digital input function activated
Remote Control to Off	Digital input function activated
Remote Control to S2	Digital input function activated
Alarm Reset	Digital input function activated
Manual-Auto Mode	Digital input function activated

Table 6.3 Info statements in level 3 and 4, LCD and touch control interfaces

7. Technical data

7.1 General technical data

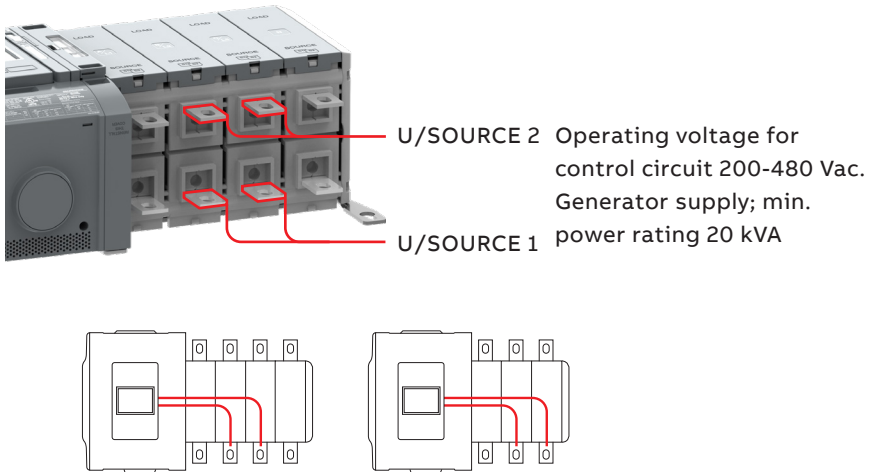
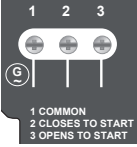

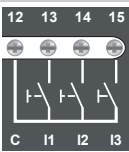

Fig. 7.1 Power supply for control and power switching circuits

Automatic transfer switch, power circuit		Value	
Rated operational voltage		200-480 Vac	
Rated frequency		50 / 60 Hz	
Rated impulse withstand voltage		12 / 8 kV	
Operating times		See Table 7.3	
Automatic transfer switch, control circuit		Value	Remark
Voltage supply		200-480 Vac	Integrated, see Fig. 7.1
Operating voltage range		±20 %	
Voltage measurement accuracy		1 %	
Rated frequency		50 / 60 Hz	
Operating frequency range		±20 %	
Frequency measurement accuracy		0.5 %	
Rated impulse withstand voltage		6 kV	

Automatic transfer switch, I/O contacts		Cabling	Rating / Remark
Generator start/stop	Cable size:	0.5...2.5 mm ² 24...14(12) AWG	Stripping length; 6,5 mm, 0,255"
	Common, voltage supply	1	5 A@250 Vac (AC-1), 5 A@30 Vdc
	Generator start/stop NO	2	
	Generator start/stop NC	3	
Output relay features	Cable size:	0.5...2.5 mm ² 24...14(12) AWG	
Common, voltage supply		5	5 A@250 Vac (AC-1), 5 A@30 Vdc
	Programmable output (default; Alarm/Product available)	6	
	Fire Fighting applications	Cable size:	0.5...2.5 mm ² 24...14(12) AWG
	Fire fighting input 24 Vdc (+)	10	SELV
	Fire fighting input 24 Vdc (-)	11	Transfers to O/OFF position, locks the logic and signals alarm
Input contact features	Cable size:	0.5...2.5 mm ² 24...14(12) AWG	Do not connect to any power supply
Common input		12	24 Vdc 5 mA
	Level 4		Level 4 = HMI with touch screen
	Programmable input (default; Emergency stop)	13	
	Programmable input (default; Remote test on load)	14	
	Programmable input (default; Remote test off load)	15	Only in ZTSD-types, delayed transition, I – O – II or II – O – I

AC15		AC12			AC13	
Ue/[V]	Ie/[A]	Ue/[V]	Ie/[A]	P/[W]	Ie/[A]	P/[W]
230	6	24	10	240	2	50
400	4	72	4	290	0.8	60
415	4	125	2	250	0.55	70
690	2	250	0.55	140	0.27	
		440	0.1	44		

Table 7.1 Technical data for auxiliary contacts according to IEC 60947-5-1, for OA1G_, OA3G_

Recommended Operating / Storage Temperature

Do not store the automatic transfer switch in corrosive environments above LC1 (sea salt mist) and G1 as per ANSI/ ISA-S71.04-1985. Failure to comply with these instructions may result in product damage. Store the automatic transfer switch and related accessories in a clean, dry location in their original packaging.

Environmental	Value
Environments category	E
EMC environment	A and B
Operating temperature (without derating)	-20... +40 °C
Operating temperature (with derating)	-25... +70 °C
Transportation and storage temperature	-40... +70 °C
Altitude (without derating)	Up to 2000 m

Table 7.2 General technical data of automatic transfer switch

Type	Voltage [Vac]	Nominal current* [A]	Operating time* = current duration I-0, 0-I, 0-II, II-0 [ms]	Operating transfer time ^{1,2} AUTO mode I-II or II-I [ms]	Contact transfer time ¹ I-II or II-I [ms]
ZTS 30 - 260A	200 - 480	37	-	< 500	< 50
ZTSD 30 - 260A	200 - 480	37	< 110	< 500	< 50
ZTS 400 - 600A	200 - 480	40	-	< 500	< 50
ZTSD 400 - 600A	200 - 480	40	< 130	< 500	< 50
ZTS 800 - 1200A	200 - 480	40	-	< 500	< 50
ZTSGD 800 - 1200A	200 - 480	40	< 130	< 500	< 50

¹Under nominal conditions

²Time from source fail detection to contact closing on already-available secondary source

³All times consider that all timers are set to "0"

Table 7.3 Specified technical data of operating times

7.2 Circuit diagrams

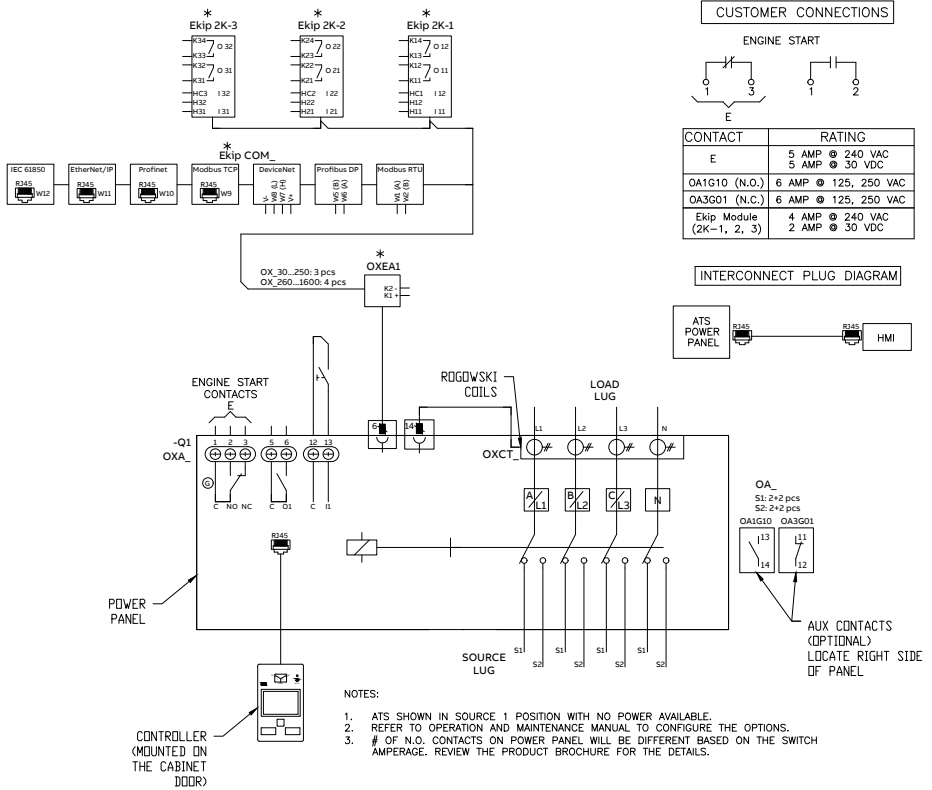

Fig. 7.2 ZTS, open transition circuit diagram

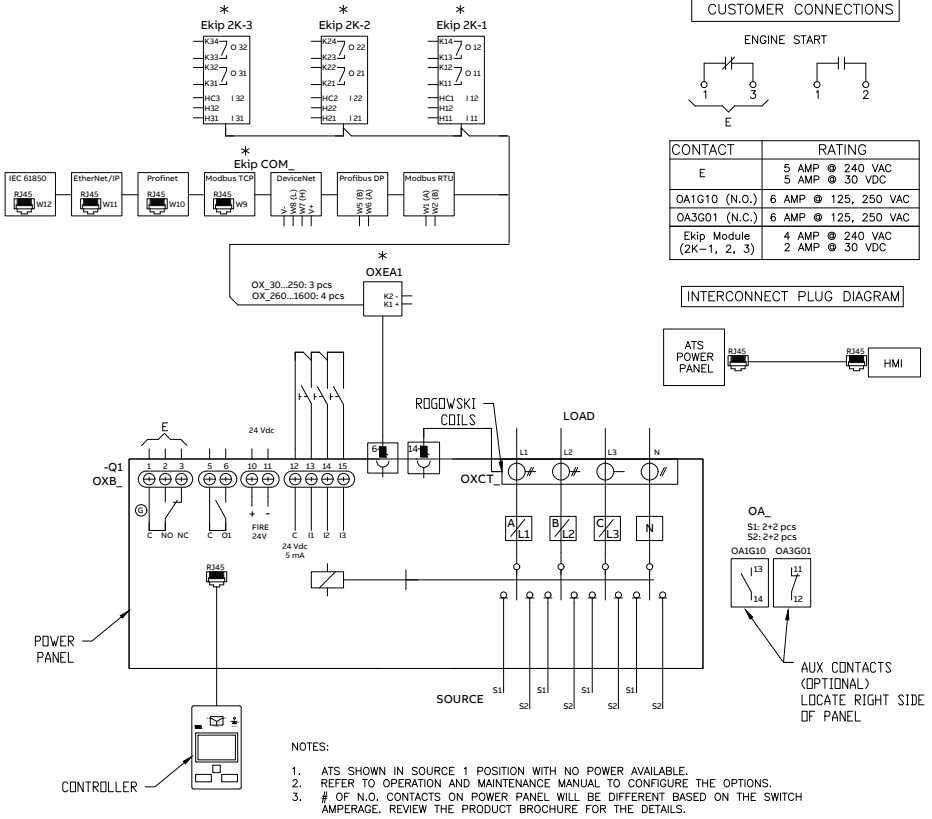

Fig. 7.3 ZTSD, delayed transition circuit diagram

7.3 Overall Dimensions

ZTS series dimensions and weights, UL Type 1 Enclosure

Model	ATS Rating (A)	Poles	Ref. Figure	Weight ¹ lb (kg)	Dimensions ² in (mm)		
					Height	Width	Depth
ZTS ZTSD	30 - 200	2	A	89 (40)	32 (813)	24 (610)	12 (305)
		3	A	93 (42)	32 (813)	24 (610)	12 (305)
		4	A	98 (44)	32 (813)	24 (610)	12 (305)
	260	2	A	145 (66)	46 (1168)	24 (610)	14 (356)
		3	A	150 (68)	46 (1168)	24 (610)	14 (356)
		4	A	155 (70)	46 (1168)	24 (610)	14 (356)
	400	2	A	153 (69)	46 (1168)	24 (610)	14 (356)
		3	A	159 (72)	46 (1168)	24 (610)	14 (356)
		4	A	290 (131)	58 (1372)	28 (711)	19.5 (495)
	600	2	B	278 (126)	58 (1372)	28 (711)	19.5 (495)
		3	B	284 (129)	58 (1372)	28 (711)	19.5 (495)
		4	B	290 (131)	58 (1372)	28 (711)	19.5 (495)
800 - 1200	3	C	482 (219)	74 (1880)	40 (1016)	19.5 (495)	
	4	C	515 (234)	74 (1880)	40 (1016)	19.5 (495)	

¹Enclosures Type 3R, 12, 4, and 4X weights are up to 22% greater than Type 1 Enclosures.

²Enclosures Type 3R, 12, 4, and 4X dimensions differ. Consult Tech Support for details.

³All dimensions and weights are approximate and subject to change without notice.

⁴Packing materials must be added to weights shown. Allow 15% additional weight for cartons, skids, crates, etc.

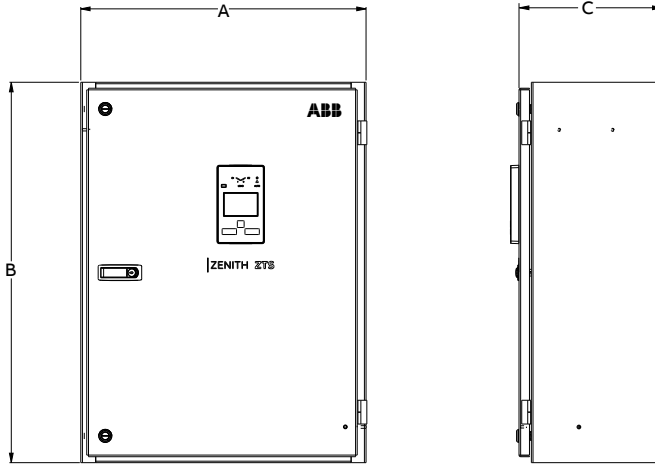

Figure A

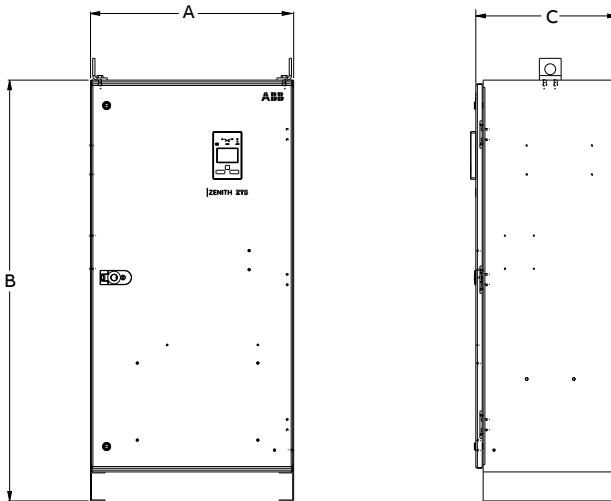

Figure B

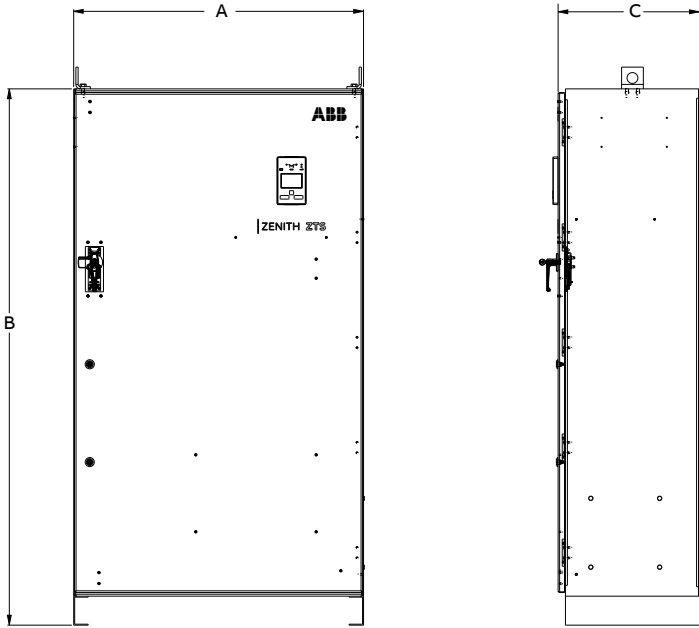

Figure C

8. Maintenance



Warning

Any maintenance should be conducted by trained and authorized personnel only. Appropriate personal protective equipment (PPE) shall be used when performing maintenance on the ATS panel. Hazardous voltage may be present. Disconnect all power sources before performing work inside the ATS panel. Failure to do so may result in serious injury or death.

Maintenance Principle

The Zenith ZTS(D) T-series 30-1200 A, 200-480 Vac automatic transfer switches, powered by TruONE™, are designed so that the contacts last their designed lifetime without any routine maintenance needs. If there are abnormal conditions such as a fault or overload without adequate protection, or extreme environment conditions, a failure of ATS components may occur. Fortunately, all critical modules, including complete mechanism with electronics (controller, power module, and solenoid mechanism), HMI, and accessories are easily replaceable. Refer to Chapter 11 for replacement parts.

On the other hand, when the contacts have seen an event, or have met the end of their lifetime, the whole switch should be replaced – which can be done easily by replacing the complete TruONE™ power panel within the enclosure.

In the case you suspect a failure may be due to manufacturer defect and covered under warranty, see Chapter 1.3.

Refer to Chapter 7 technical data for ATS contact endurance and note that the number of operations can be viewed in the information menu from the HMI.

Routine Inspection

ABB recommends a routine (such as annual) inspection to, e.g. , check electrical termination temperatures, ensure unit is clean, check voltage levels, test transfers, # of operations, etc. to ensure everything is in proper working order.

Recommended annual inspection includes:

- Review event log
- Check number of operations and other switch status figures
- Visual inspection both inside and outside of enclosure for damage or debris
- Test transfer of load
- Observe voltage levels of both sources within expected range
- Cable lug torque verification



9. Panel installation

Before mounting the product, please, check the product identification from the product identification label, which is located on the front panel under the control interface unit (HMI). This label indicates the product model (type number), some important technical data information, minimum enclosure size, suitable wire information, etc.



Notice

Final inspection of the equipment should be performed prior to energizing the automatic transfer.

Remove any dirt or debris that may have collected during shipment or installation. NEVER use compressed air. Doing so could drive dirt or other foreign objects into electrical or mechanical components, which could cause damage. Use an industrial-quality vacuum cleaner to remove any dirt or foreign objects.

Be certain all cable connections are correct and that the phase rotation of both sources match.

Inspect the engine start connections and verify the correct connection of all control wires.

Check all programmable set points and adjust as necessary. In addition, adjust any optional accessories as required.

Be certain that the actual lug torque values are in keeping with the requirements outlined in the instruction book to ensure the integrity of power connections.

Check to be sure that all covers and barriers are properly installed and fastened.

If any damage is found or suspected, file a claim as soon as possible with the carrier, and notify the nearest ABB Zenith representative, or call 1-800-637-1738.

9.1 Basic Tools for Installation and Maintenance

Tool	Task
1/4" to 1/2" Allen head socket driver	Power cable connection
Torque wrench	Torquing of the lugs and other hardware as required. Range of device to be 50 - 500 in-lbs (5-57 N-m)
Torque screwdriver	Torquing of control wire terminations, auxiliary contact input terminals. 5 - 25 in-lbs (0.5 - 2.8 N-m)
Wire cutters/wire crimpers	Auxiliary contacts wire installation, Options installation
Voltmeter	Trouble shooting tool for measuring incoming voltage, frequency, continuity and control signal transmission.
Controller default password 00001	Changing parameters within the controller

Table 9.1 Required tools for common installation and maintenance tasks

9.2 Equipment Inspection and Storage



Warning

When performing a hi-pot or dielectric test on the power section of the ATS panel, DISCONNECT the complete electronics, controller, and mechanism section of the ATS from the power section to avoid potential damage to the electronics.

Before installation, if it is necessary, store the transfer switch in a clean dry place, protected from dirt and water. Provide ample air circulation and heat, if necessary, to prevent condensation.

See table 7.2 for recommended storage and ambient operating temperatures.

Once you have received the transfer switch, inspect it for any damage. This includes damage to the enclosure, power panel, control panel and wiring harness. If any damage is found or suspected, file a claim as soon as possible with the carrier and notify the nearest ABB Zenith representative.

9.3 Lifting and Mounting the Panel

Lifting guidelines

Adequate lifting means must be used to mount the transfer switch into place. The recommended method for moving the ATS, up to 1200 A, is with lifting strap and lifting equipment rated for the equipment weight.

Lifting, Mounting and Installation

The safe operation of your switch at all times is paramount to ABB. Please recognize that hazardous voltages and currents can exist during normal operation, and any maintenance on the transfer switch must be performed utilizing appropriate safety measures. Installation, adjustment, maintenance or removal of the switch must only be carried out by qualified personnel and with all power to the switch turned off. It is recommended that only qualified electricians be allowed to install or provide maintenance on the switch.

Prior to installation, store the transfer switch in a clean dry location, protected from dirt and water. Provide ample air circulation and heat if necessary to prevent condensation. See table 7.2 for recommended storage and ambient operating temperatures.

ABB Zenith automatic transfer switches are packaged as per the standard packaging regulatory standards requirement suitable for domestic and international shipment through all modes of transportation (air, sea and road). Once you unpack the units, please make sure all the components are received as per the BOM. For any missing items, contact your local ABB Zenith service representative.



Danger
Hazardous Voltage can Cause Severe Injury or Death

Turn OFF all power before installation, adjustment, or removal of transfer switch or any of its components.



Warning

Due to hazardous voltages and currents, ABB recommends that an ABB Certified technician or a qualified electrician perform the installation & maintenance of the switch.



Danger
Hazardous Voltage can Cause Severe Injury or Death

Automatic Transfer Switch Equipment must be electrically grounded. Failure to do so may result in malfunction of the switch and possible damage to surrounding equipment.



Warning

Before drilling conduit entry holes or any accessory mounting holes, cover and protect the switch and control panel to prevent dirt and metal fragments from entering the mechanical and electrical components.

9.4 Mounting the automatic transfer switch

9.4.1 Mounting hole dimensions

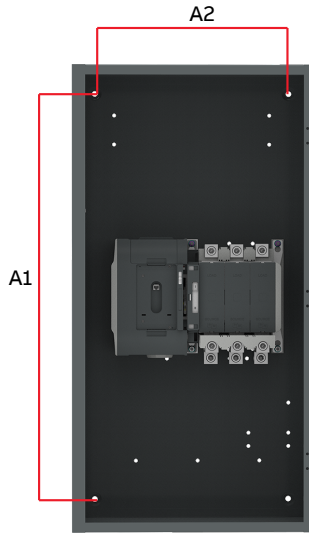

Fig. 9.1 Automatic transfer switches, Mounting hole dimensions, refer to Table 9.2 for A1 and A2 values

Enclosure mounting dimensions

Model	ATS Rating (A)	Poles	Type 1, in (mm)		Type 3R/4/4X/12, in (mm)	
			Height (A1)	Width (A2)	Height (A1)	Width (A2)
ZTS ZTSD	30 - 200	2	28.0 (711)	20.0 (508)	33.3 (845)	18.0 (457)
		3	28.0 (711)	20.0 (508)	33.3 (845)	18.0 (457)
		4	28.0 (711)	20.0 (508)	33.3 (845)	18.0 (457)
	260	2	42.0 (1067)	20.0 (508)	47.25 (1200)	18.0 (457)
		3	42.0 (1067)	20.0 (508)	47.25 (1200)	18.0 (457)
		4	42.0 (1067)	20.0 (508)	47.25 (1200)	18.0 (457)
	400	2	42.0 (1067)	20.0 (508)	47.25 (1200)	18.0 (457)
		3	42.0 (1067)	20.0 (508)	47.25 (1200)	18.0 (457)
		4	50.0 (1168)	24.0 (610)	55.25 (1302) ¹	22.0 (559)
	600	2	50.0 (1168)	24.0 (610)	55.25 (1302) ¹	22.0 (559)
		3	50.0 (1168)	24.0 (610)	55.25 (1302) ¹	22.0 (559)
		4	50.0 (1168)	24.0 (610)	55.25 (1302) ¹	22.0 (559)
800 - 1200	3	66.0 (1676)	35.0 (889)	71.25 (1810)	34.0 (864)	
	4	66.0 (1676)	35.0 (889)	71.25 (1810)	34.0 (864)	

¹ 4X enclosures add 0.05 inches to dimensions

Table 9.2 Zenith ZTS(D) panel mounting dimensions

9.4.2 HMI Installation

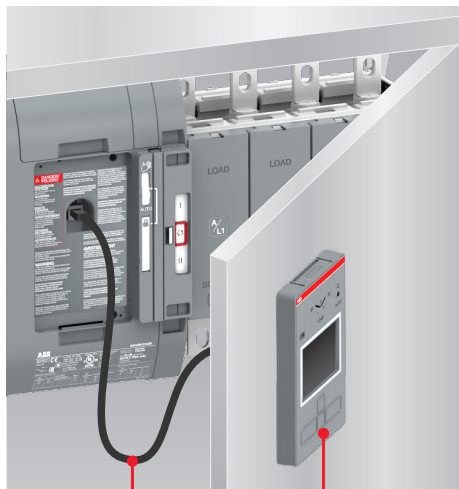

Cable supplied
with unit

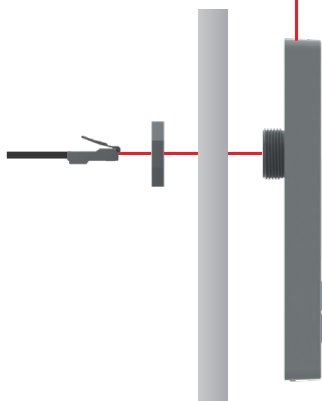

A07490

Fig. 9.2 HMI can be mounted on the switch or the door, door drilling. HMI protective cover available as accessory, type OXEC21, provides protection against accidental contact, see Chapter 10.4, Mounting of accessories.

9.5 Wire Connection



Notice
Lugs come pre-installed and torqued

AL/CU UL Listed Solderless Screw-Type Terminals for External Power Connections

Model	ATS Rating (A)	Source/Load	Lug Type	Wire Range	Cables per pole	Cables - Tightening Torque ¹ , lb-in (N-m)
ZTS ZTSD	30 - 60	Source 1	OZXA-24	14 - 2/0 AWG	1	50/5.7
		Source 2 / Load	OZXA-100	12 - 2/0 AWG	1	132/15.0
	100 - 200	Source 1	OZXA-25	6 AWG - 300 MCM	1	275 / 31.1
		Source 2 / Load	OZXA-200	4 AWG - 300 MCM	1	200 / 22.6
	260 - 400	Source 1	OZXA-412L	1x4 AWG - 600 MCM or 2 x 1/0 AWG - 250 MCM	1/2	500 / 56.5
		Source 2 / Load	OZXA-412	1x 4 AWG - 600 MCM or 2 x 1/0 AWG - 250 MCM	1/2	500 / 56.5
	600	Source 1	OZXA-800L	2 AWG - 600 MCM	2	500/56.5
		Source 2 / Load	OZXA-800E	2 AWG - 600 MCM	2	500/56.5
	800 - 1200	Source 1	OZXA-1200	2 AWG - 600 MCM	4	500/56.5
		Source 2	OZXA-800S	2 AWG - 600 MCM	4	500/56.5
		Load	OZXA-1200	2 AWG - 600 MCM	4	500/56.5

¹Do not exceed this value - may cause damage to switch, voiding warranty

Table 9.3 Power Cable Torque Requirements

9.6 Final Equipment Inspection

Prior to energizing the transfer switch:

1. Remove any debris incurred, with a vacuum, due to shipment or installation.
2. Verify that all cabled connections are correct and that phase rotation of both sources match.
3. Check engine start connections.
4. Verify the correct connection of all control wires.
5. Check settings of all timers and adjust as necessary.
6. Adjust any optional accessories as required.
7. Check the lug torque values of the power connections.
8. Make sure that all covers and barriers are installed and properly fastened.

For simple details on start-up refer to ZTS Quick start guide document number 1SCC303027K0201.

Each ABB Zenith transfer switch is factory wired and tested. A complete information package is furnished with each switch which includes:

- Sequence of operation.
- Description and operation of all accessories supplied.
- Power panel connection diagram and schematic.
- Description and identification of all customer field connections.

Installation of ABB Zenith transfer switches includes:

- Mounting the transfer switch cabinet.
- Connection of Source 1, Source 2, and Load cables or bus bars.
- Connection of external control circuits as required.

9.7 Initial Energizing

Before proceeding, refer to the information package supplied with the ATS and read and understand the information on all accessories provided, including this complete document.

Before energizing the panel

1. Confirm that installation has been performed by a qualified person and in accordance with NFPA 70 (NEC).



Notice

This installation should be properly operated and maintained in accordance with the safety practices of NFPA 70E.

2. Confirm rating label matches the installed application. Rating label is located inside the panel enclosure.
3. Confirm that cables are connected properly and torqued according to the ATS labeling.
4. Verify that the enclosure ground connection is properly terminated.
5. Confirm that control wiring for engine start is properly terminated to the engine start contact (located in Figure 2.1, number 8). Additionally, connect all applicable digital I/O, communications, and auxiliary contact wiring.
6. Flip slide switch (Figure 2.1, number 4) to AUTO.
7. Ensure that all objects and debris are removed from enclosure, and enclosure is closed and latched.

Energizing the panel

1. Close Source 1 circuit breaker.

NOTE: The HMI should illuminate if line voltage is present and S1 LED should light up.

2. Verify the phase to phase voltages at the Source 1 terminals.
3. Initiate auto configure from HMI default screen: Main Menu > Parameters > System Parameters > Start Automatic Configuration and allow a few seconds for system parameters to set"

4. Close the Source 2 circuit breaker.

5. Start the generator engine.

NOTE: If generator voltage is present at Source 2 terminals, S2 LED should light up.

6. Verify phase rotation of S1 matches that of S2.

NOTE: The ATS will not allow transfer if phase rotation does not match.

7. Shut down the generator engine.

8. For additional start-up guidance for the ATS, please refer to ZTS Mini Manual, document number 1SCC303039M0201.



10. Accessories



Warning

Any troubleshooting should be conducted by trained and authorized personnel only. Appropriate personal protective equipment (PPE) shall be used when troubleshooting the ATS panel. Hazardous voltage may be present. Disconnect all power sources before performing work inside the ATS panel. Failure to do so may result in serious injury or death.

More information, see animation:
Installation of accessories - TruONE™ ATS
(<https://youtu.be/qV2Kolv38GY>).



10.1 Phase barriers

Phase barriers must be used to maintain a clearance of 1 inch on the automatic transfer switch types. They are included with the shipment of ZTS T-series ATS Panel.

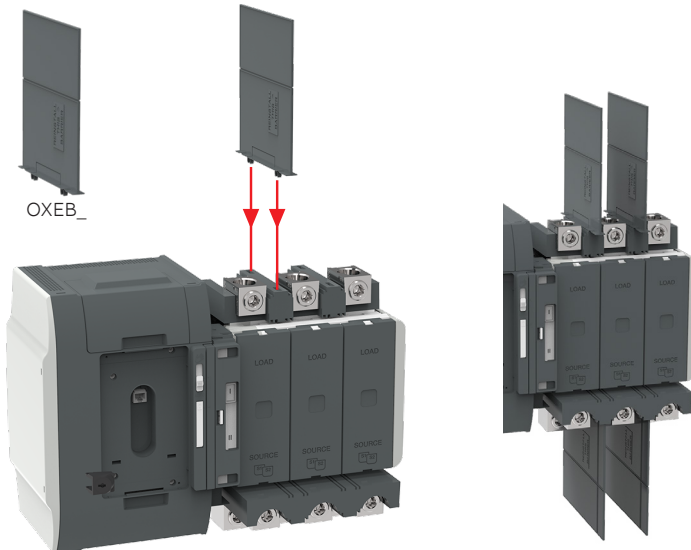

Fig. 10.1 Mounting of phase barriers, type OXEB_

10.2 Auxiliary contact blocks

Refer to Figure 7.1 for auxiliary contact ratings.

Position	OA1G10	OA3G01
SOURCE 1 (S1), max 2+2		
I		
O		
II		
SOURCE 2 (S2), max 2+2		
I		
O		
II		

Table 10.1 Contact positions

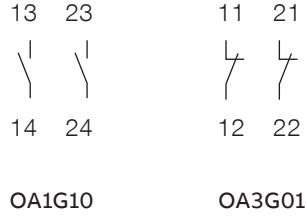

Fig. 10.3 Labels for contact numbering

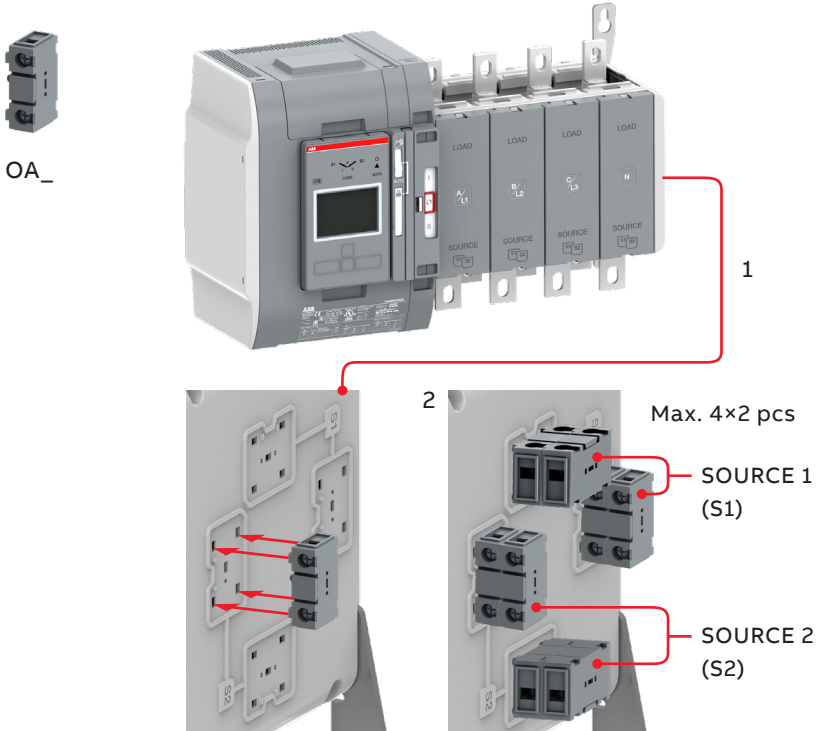

Fig. 10.2 Mounting of the auxiliary contact blocks, type OA_

10.3 Auxiliary power supply and Ekip -modules

ZTS(D) 30-1200 A, 200-480 Vac Automatic transfer switches can be equipped with Ekip-modules. Ekip-modules are mounted with a auxiliary power supply module, OXEA1. Suitable Ekip-modules are: Ekip link, signalling and connectivity modules. For more information, see Chapter 5, Electronic accessories.

The maximum number of Ekip-modules varies by panel ampacity :

- 30-200 A: 3 Ekip modules
- 260-400 A: 4 Ekip modules

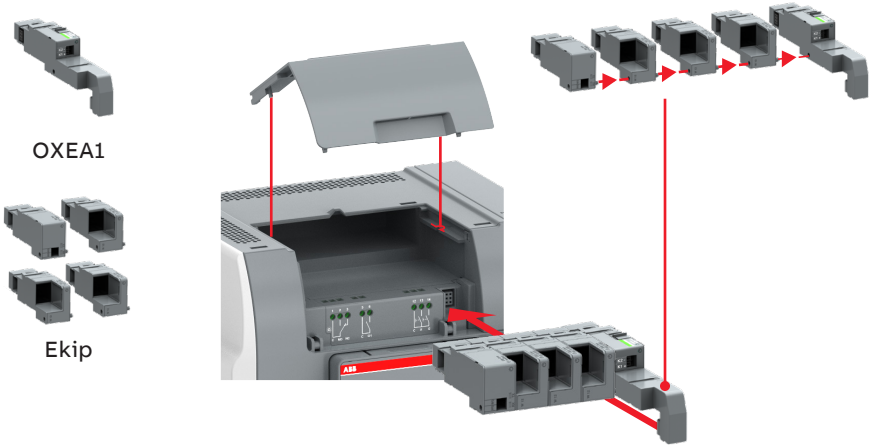

Fig. 10.4 Mounting of the auxiliary power supply module OXEA1 and Ekip –modules

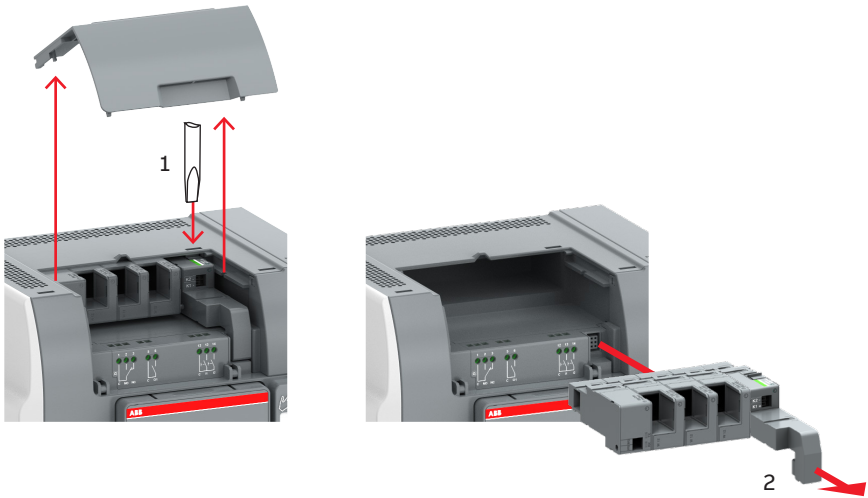
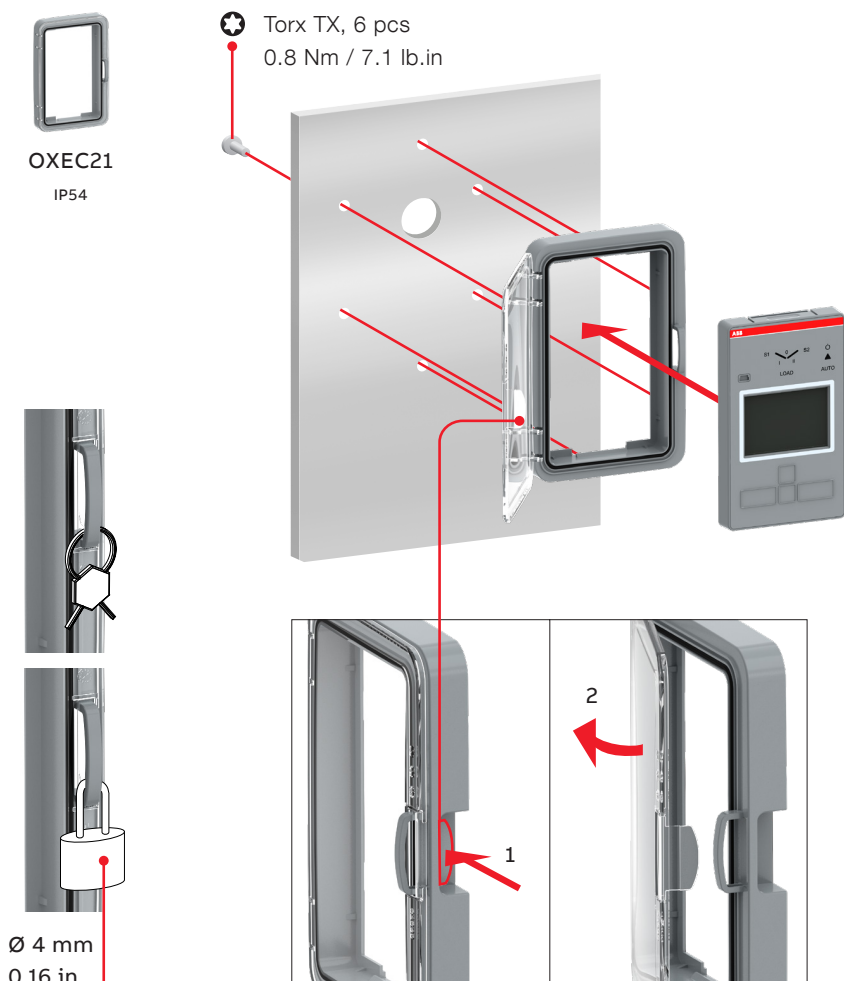

Fig. 10.5 Removing the auxiliary power supply module OXEA1 and Ekip –modules from the automatic transfer switch

10.4 HMI protective cover

UL Type 3R HMI protective cover, type OXEC21, provides protection against water ingress. It comes standard with NEMA 3R enclosures, and is available as a replacement part.

Fig. 10.6 Mounting of HMI protective cover, type OXEC21





11. Replacement Parts

ZTS series replacement parts

Category	Application/Description	Order code
HMI	Open transition (ZTS 30-1200 A, 200-480 Vac)	OXAHMI-L4
	Delayed transition (ZTSD 30-1200 A, 200-480 Vac)	OXBHMI-L4
	ETHERNET - CAT 5e CABLE - 7FT	OXCAT5E-7FT (PS-9862)
	ETHERNET - CAT 5e CABLE - 10FT	OXCAT5E-10FT (PS-9863)
Manual handle	Open transition and delayed transition (ZTS(D) 30-1200 A, 200-480 Vac)	OXHANDLE-1600
Complete ¹ mechanism with electronics	Open transition (ZTS, 200-480 Vac)	
	30-260 Amps	OXAMECH-2-L4
	400-600 Amps	OXAMECH-3-L4
	800-1200 Amps	OXAMECH-4-L4
	Delayed transition (ZTSD, 200-480 Vac)	
	30-260 Amps	OXBMECH-2-L4
	400-600 Amps	OXBMECH-3-L4
Phase barrier	30-1200 Amps, 3 pole	OXEB1600/4
	30-1200 Amps, 4 pole	OXEB1600/6
	ETHERNET - CAT 5e CABLE - 7FT	OXCAT5E-7FT (PS-9862)
	ETHERNET - CAT 5e CABLE - 10FT	OXCAT5E-10FT (PS-9863)
	Ekip Programming	ZEAKEPPGM
	Window Kit	Window Kit NEMA 4/4X/12 - No Meter
Window Kit NEMA 4/4X/12 - With Meter		OXWINDOWKIT (PS-9931)
HMI protective cover, IP54		OXEC21
Cover kit		OXCOVERKIT
Rogowski coils	Rogowski 30-260A, 3P	OXSENSOR-2-3P
	Rogowski 30-260A, 4P	OXSENSOR-2-4P
	Rogowski 400-600A, 3P	OXSENSOR-3-3P
	Rogowski 400-600A, 4P	OXSENSOR-3-4P
	Rogowski 800-1200A, 3P	OXSENSOR-4-3P
	Rogowski 800-1200A, 4P	OXSENSOR-4-4P
COM Accessories	Ekip Com Modbus RTU-OX	ZEAMOD485
	Ekip Com Modbus TCP-OX	ZEAMODTCP
	Ekip Com Profibus	ZEAPRFIBUS
	Ekip Com Profinet	ZEAPRFINET
	Ekip Com EtherNet / IP	ZEAETHRNT
	Ekip Com Hub	ZEAEKIPHUB
	Ekip Com DeviceNet	ZEADEVICNET
Ekip Programming	ZEAKEPPGM	

Continued on the next page

ZTS series replacement parts (continued)

Category	Application/Description	Order code		
AUX Contacts	Ekip Signalling 2K-1-OX	2K-1-OX		
	Ekip Signalling 2K-2-OX	2K-2-OX		
	Ekip Signalling 2K-3-OX	2K-3-OX		
	Aux contact NO	OA1G10		
	Aux contact NC	OA3G01		
Suitable for UL switches	No. of Poles	Lug Kit Application		
		Source S2	Load	Source S1
30 - 60	2	1 X OZXA-100/4P		OZXA-24/2P
	3	1 X OZXA-100		OZXA-24/3P
	4	2 X OZXA-100/4P		OZXA-24/4P
100 - 200	2	1 X OZXA-200/4		OZXA-25/2P
	3	1 X OZXA-200		OZXA-25/3P
	4	2 x OZXA-200/4		OZXA-25/4P
260 - 400	2	1 X OZXA-412/4		OZXA-412L/2P
	3	1 X OZXA-412		OZXA-412L/3P
	4	2 X OZXA-412/4		OZXA-412L/4P
600	3	1 X OZXA-800E		OZXA-800L/3
	4	2 x OZXA-800E/4P		OZXA-800L/4
800 - 1200	3	OZXA-800S	OZXA-1200	
	4	2 X OZXA-800S/4P	2 X OZXA-1200/4	

¹Includes the tested, field replaceable module complete with operating mechanism, power module, and controller

Fig. 11.1 Replacement parts, available in Empower

**Consult factory for lug application.
For other accessories refer to the manual
1SXU523001C0201.**



Contact us

ABB Zenith Controls, Inc.

305 Gregson Drive
Cary, NC 27511

24-hour support:

ABB Technical Services
+1 (800) 637-1738
epis.pqservice@abb.com

abb.com/lowvoltage